

LS-TYPE series

On stage

The **LS-TYPE** enclosures are the ideal solution for the entertainment industry (lighting system power supply and related mixer and dimmer panels), including theatre stages, film sets, radio and TV studios, discos, trade fair booths, concert halls and night public events, both indoors and outdoors, etc.

All parts are in elegant RAL 9005 black to make them suitable for situations and locations where they should not be visible in the dark.

Functional characteristics

These enclosures can be installed beside stages.

They do not have any bright components that would distract and simple plastic levers that are easy to replace.

- ✔ UL certified for USA and Canada for NEMA 4, NEMA 4X and NEMA 12 degrees of protection (enclosure type ratings) printed on the packaging.
IP65/IP69 degree of protection.



SUM-UP OF MATERIALS USED FOR CH..N - MA..N and MH..N - MF..N LS-TYPE series

- ☐ **Made of die cast aluminium alloy**
- ☐ **Powder-coated with RAL 9005**
- ☐ **Gaskets in anti-aging, oil resistant, grease resistant and fuel resistant vinyl nitrile elastomer**
- ☐ **Locking device with levers in black made of plastic**
- ☐ **Ambient temperature range -40 °C / +125 °C.**

CH..N - MA..N and MH..N - MF..N LS-TYPE version

inserts		page:
CDD	24 poles + ⊕	76
CDS	9 poles + ⊕	-
CDSH	9 poles + ⊕	86
CDSH NC	6 poles + ⊕	95
CNE	6 poles + ⊕	110
CSE	6 poles + ⊕	-
CSH	6 poles + ⊕	110
CSH S	6 poles + ⊕	122
CCE	6 poles + ⊕	130
CSS	6 poles + ⊕	148
CT, CTSE (16A) *	6 poles + ⊕	160
CQE	10 poles + ⊕	168
MIXO	2 modules	262 - 317

*) only in the CHIN 06 LCH and CHIN 06 L enclosure

housings with 2 pegs and 1 lever



hoods with 2 pegs



description	part No.	entry M	part No.	entry M
bulkhead mounting housing, with 2 pegs	CHIN 06 LCH			
bulkhead mounting housing, with lever	CHIN 06 L			
surface mounting housing, high construction, with lever	MAPN 06 L32	32		
with pegs, side entry			MHON 06 L25	25
with pegs, top entry			MHVN 06 L25	25
with pegs, side entry, high construction, without adapter ¹⁾			MFON 06 L25	25
with pegs, top entry, high construction, without adapter ¹⁾			MFVN 06 L25	25

¹⁾ enclosure without adapter, threaded on the enclosure body, to be used only with a complete cable gland.

- kiln powder coating with RAL 9005 black epoxy polyester powder
- RAL 9005 black self-extinguishing thermoplastic locking lever

CHIN LCH

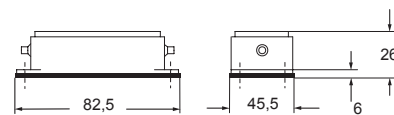

CHIN L

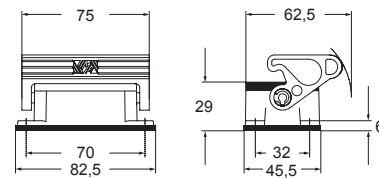

MAPN L32

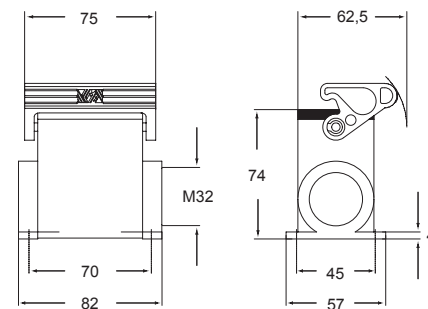

panel cut-out for bulkhead mounting housings CHIN LCH and CHIN L

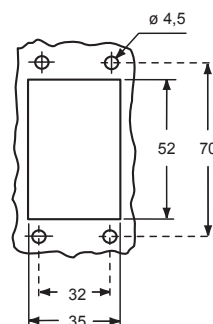

MHON L25

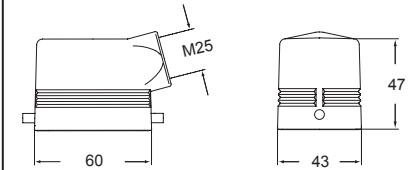

MHVN L25

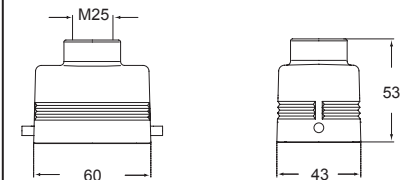

MFON L25

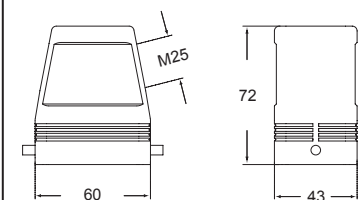

MFVN L25

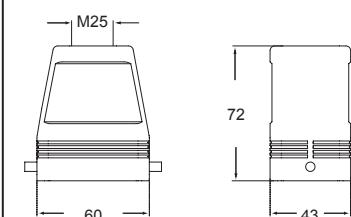

CR LN
Spare part lever for "44.27" enclosures with levers

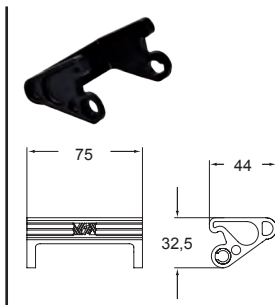

CAIUS Type 4/4X/12



CH..N and MH..N - MF..N LS-TYPE version

inserts		page:
CDD	24 poles + ⊕	76
CDS	9 poles + ⊕	-
CDSH	9 poles + ⊕	86
CDSH NC	6 poles + ⊕	95
CNE	6 poles + ⊕	110
CSE	6 poles + ⊕	-
CSH	6 poles + ⊕	110
CSH S	6 poles + ⊕	122
CCE	6 poles + ⊕	130
CSS	6 poles + ⊕	148
CQE	10 poles + ⊕	168
MIXO	2 modules	262 - 317

hoods with single lever



covers



description	part No.	entry M	part No. (with eyelet)	part No. (with loop)
-------------	----------	---------	------------------------	----------------------

with lever and gasket, top entry
with lever and gasket, top entry, high construction, without adapter ¹⁾

MHVN 06 LG25 25
MFVN 06 LG25 25

covers with pegs
covers with lever

CHCN 06 L

CHCN 06 LG

¹⁾ enclosure without adapter, threaded on the enclosure body, to be used only with a complete cable gland.

- kiln powder coating with RAL 9005 black epoxy polyester powder
- RAL 9005 black self-extinguishing thermoplastic locking lever

MHVN LG25

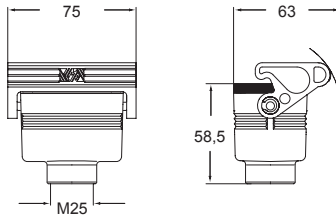

MFVN LG25

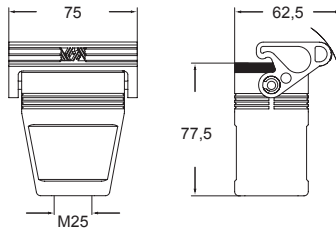

CHCN L

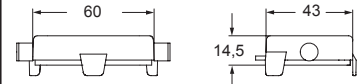

CHCN LG

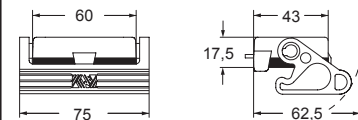

CR LN
Spare part lever for "44.27" enclosures with levers

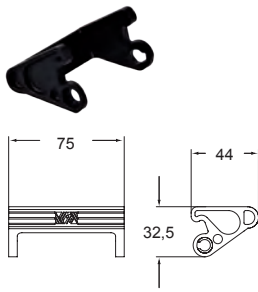

CRUS Type 4/4X/12



For fixing on housings

eyelet

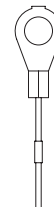

For fixing on hoods

loop

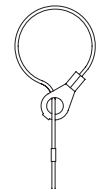

CH..N - MA..N and MH..N - MF..N LS-TYPE version

inserts		page:
CDD	42 poles + ⊕	78
CDS	18 poles + ⊕	-
CDSH	18 poles + ⊕	87
CNE	10 poles + ⊕	111
CSE	10 poles + ⊕	-
CSH	10 poles + ⊕	111
CSH S	10 poles + ⊕	123
CCE	10 poles + ⊕	131
CMSH	3+2 (aux) poles + ⊕	136
CMCE	3+2 (aux) poles + ⊕	137
CSS	10 poles + ⊕	149
CT, CTSE (16A) *)	10 poles + ⊕	161
CQE	18 poles + ⊕	169
CX	8/24 poles + ⊕	194
MIXO	3 modules	262 - 317

*) only in the CHIN 10 CH and CHIN 10 enclosure

housings with 4 pegs and 2 levers



hoods with 4 pegs



description	part No.	entry	part No.	entry
		M		
bulkhead mounting housing, with 4 pegs	CHIN 10 CH			
bulkhead mounting housing, with 2 levers	CHIN 10			
surface mounting housing, high construction, with 2 levers	MAPN 10.32	32		
with pegs, side entry			MHON 10.25	25
with pegs, top entry			MHVN 10.25	25
with pegs, side entry, high construction, without adapter ¹⁾			MFON 10.32	32
with pegs, top entry, high construction, without adapter ¹⁾			MFVN 10.32	32

¹⁾ enclosure without adapter, threaded on the enclosure body, to be used only with a complete cable gland.

- kiln powder coating with RAL 9005 black epoxy polyester powder
- RAL 9005 black self-extinguishing thermoplastic locking lever

CHIN CH

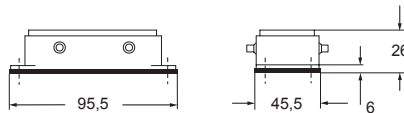

CHIN

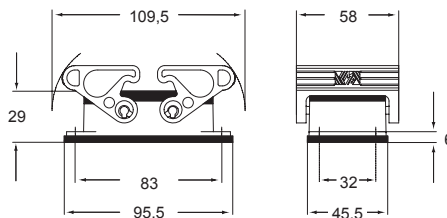

MAPN

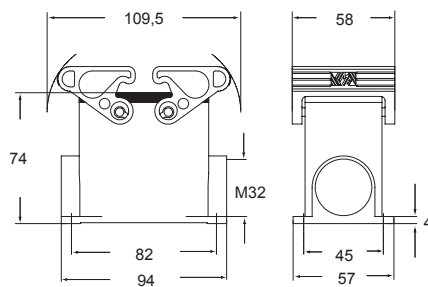

panel cut-out for bulkhead mounting housings
CHIN CH and CHIN

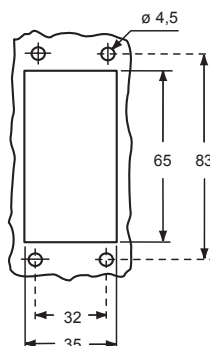

MHON

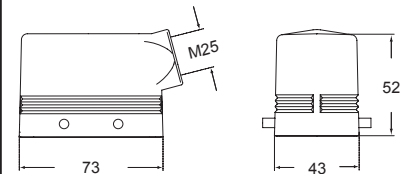

MHVN

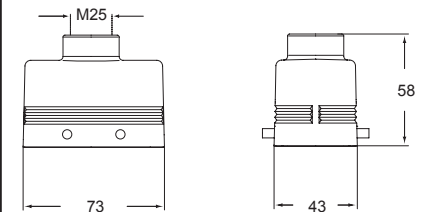

MFON

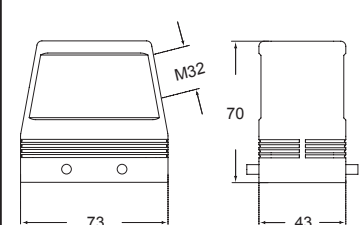

MFVN

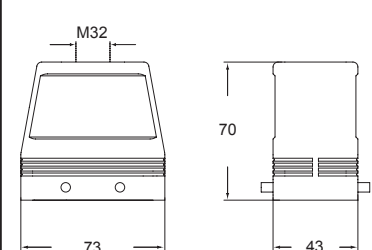

CR LN
Spare part
lever
for "57.27"
enclosures
with levers

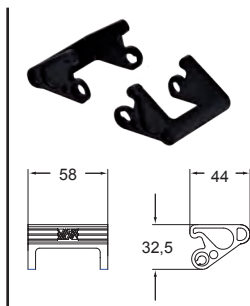

CAUS Type 4/4X/12



CH..N and MH..N - MF..N LS-TYPE version

inserts		page:
CDD	42 poles + ⊕	78
CDS	18 poles + ⊕	-
CDSH	18 poles + ⊕	87
CNE	10 poles + ⊕	111
CSE	10 poles + ⊕	-
CSH	10 poles + ⊕	111
CSH S	10 poles + ⊕	123
CCE	10 poles + ⊕	131
CMSH	3+2 (aux) poles + ⊕	136
CMCE	3+2 (aux) poles + ⊕	137
CSS	10 poles + ⊕	149
CQE	18 poles + ⊕	169
CX	8/24 poles + ⊕	194
MIXO	3 modules	262 - 317

hoods with 2 levers



covers



description	part No.	entry M	part No. (with eyelet)	part No. (with loop)
-------------	----------	---------	------------------------	----------------------

with levers and gasket, top entry	MHVN 10 G25	25		
with levers and gasket, top entry, high construction, without adapter ¹⁾	MFVN 10 G220	20 x 2		
with levers and gasket, top entry, high construction, without adapter ¹⁾	MFVN 10 G32	32		

covers with pegs			CHCN 10	
covers with 2 levers				CHCN 10 G

¹⁾ enclosure without adapter, threaded on the enclosure body, to be used only with a complete cable gland.

- kiln powder coating with RAL 9005 black epoxy polyester powder
- RAL 9005 black self-extinguishing thermoplastic locking lever

MHVN G25

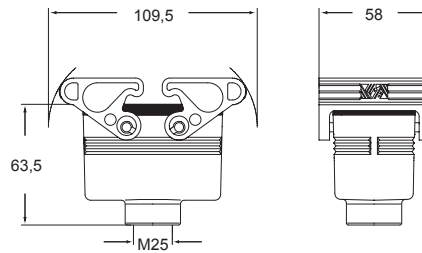

MFVN 10 G220

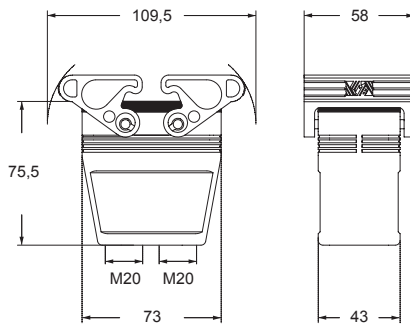

MFVN G32

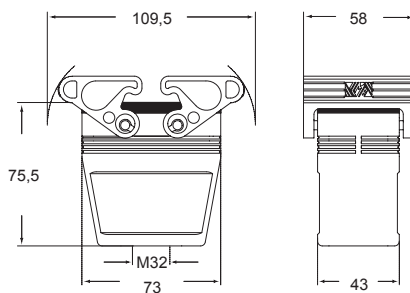

CHCN

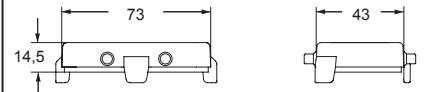

CHCN G

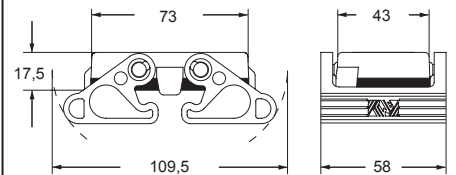

CR LN
Spare part lever for "57.27" enclosures with levers

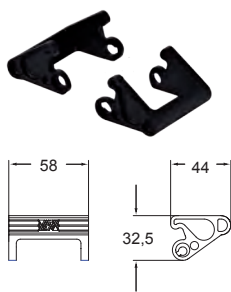

CRUS Type 4/4X/12



For fixing on housings

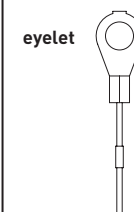

For fixing on hoods

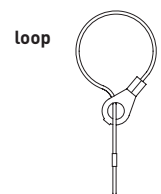

CH..N - MA..N and MH..N - MF..N LS-TYPE version

inserts		page:
CD	40 poles + ⊕	70
CDD	72 poles + ⊕	79
CDS	27 poles + ⊕	-
CDSH	27 poles + ⊕	88
CNE	16 poles + ⊕	112
CSE	16 poles + ⊕	-
CSH	16 poles + ⊕	112
CSH S	16 poles + ⊕	124
CCE	16 poles + ⊕	132
CMSH, CMCE	6+2 (aux) poles + ⊕	138 - 139
CSS	16 poles + ⊕	150
CT, CTS (10A) *)	40 poles + ⊕	156
CT, CTSE (16A) *)	16 poles + ⊕	162
CQE	32 poles + ⊕	170
CQEE	40 poles + ⊕	176
CP	6 poles + ⊕	178
CX	6/12, 6/36 and 12/2 poles + ⊕	197 - 199
CX	4/0 and 4/2 poles + ⊕	200 - 201
MIXO	4 modules	262 - 317

*) only in the CHIN 16 CH and CHIN 16 enclosure

housings with 4 pegs and 2 levers



hoods with 4 pegs



description	part No.	entry M	part No.	entry M
bulkhead mounting housing, with 4 pegs	CHIN 16 CH			
bulkhead mounting housing, with 2 levers	CHIN 16			
surface mounting housing, high construction, with 2 levers	MAPN 16.32	32		
with pegs, side entry			MHON 16.32	32
with pegs, top entry			MHVN 16.32	32
with pegs, side entry, high construction, without adapter ¹⁾			MFON 16.32	32
with pegs, top entry, high construction, without adapter ¹⁾			MFVN 16.32	32

¹⁾ enclosure without adapter, threaded on the enclosure body, to be used only with a complete cable gland.

- kiln powder coating with RAL 9005 black epoxy polyester powder
- RAL 9005 black self-extinguishing thermoplastic locking lever

CHIN CH

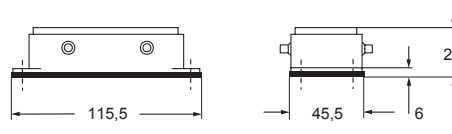

CHIN

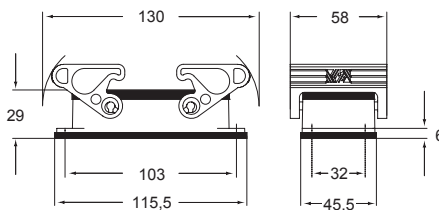

MAPN

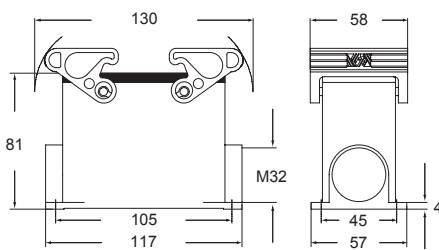

panel cut-out for bulkhead mounting housings
CHIN CH and CHIN

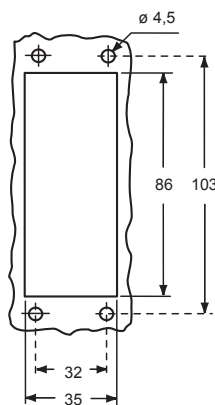

MHON

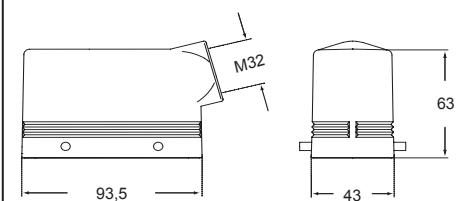

MHVN

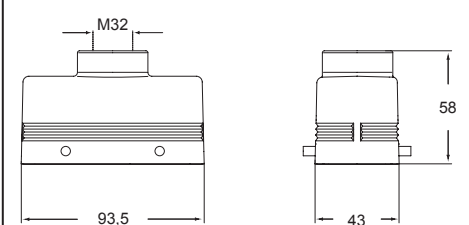

MFON

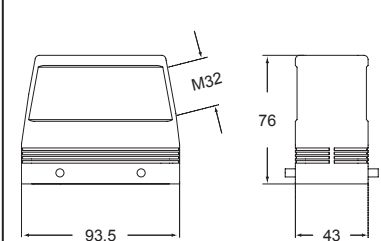

MFVN

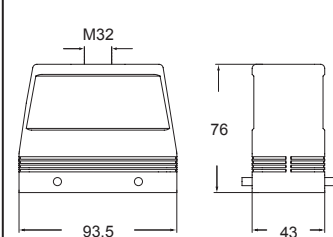

CR LN
Spare part lever
for "77.27"
enclosures
with levers

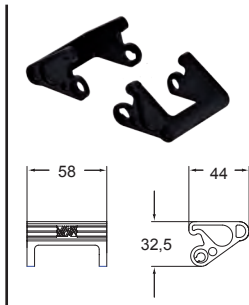

CAIUS Type 4/4X/12



CH..N and MH..N - MF..N LS-TYPE version

inserts		page:
CD	40 poles + ⊕	70
CDD	72 poles + ⊕	79
CDS	27 poles + ⊕	-
CDSH	27 poles + ⊕	88
CNE	16 poles + ⊕	112
CSE	16 poles + ⊕	-
CSH	16 poles + ⊕	112
CSH S	16 poles + ⊕	124
CCE	16 poles + ⊕	132
CMSH, CMCE	6+2 (aux) poles + ⊕	138 - 139
CSS	16 poles + ⊕	150
CQE	32 poles + ⊕	170
CQEE	40 poles + ⊕	176
CP	6 poles + ⊕	178
CX	6/12, 6/36 and 12/2 poles + ⊕	197 - 199
CX	4/0 and 4/2 poles + ⊕	200 - 201
MIXO	4 modules	262 - 317

hoods with 2 levers



covers



description	part No.	entry M	part No. (with eyelet)	part No. (with loop)
-------------	----------	---------	------------------------	----------------------

with levers and gasket, top entry	MHVN 16 G32	32		
with levers and gasket, top entry, high construction, without adapter ¹⁾	MFVN 16 G225	25 x 2		
with levers and gasket, top entry, high construction, without adapter ¹⁾	MFVN 16 G32	32		

covers with pegs
covers with 2 levers

CHCN 16

CHCN 16 G

¹⁾ enclosure without adapter, threaded on the enclosure body, to be used only with a complete cable gland.

- kiln powder coating with RAL 9005 black epoxy polyester powder
- RAL 9005 black self-extinguishing thermoplastic locking lever

MHVN G32

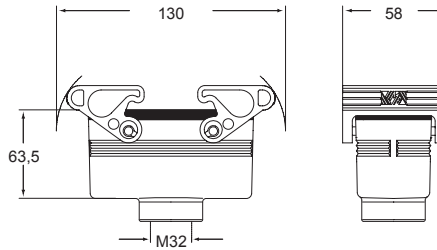

MFVN 16 G225

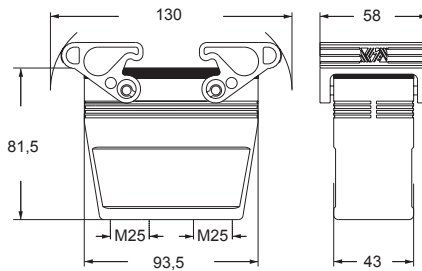

MFVN G32

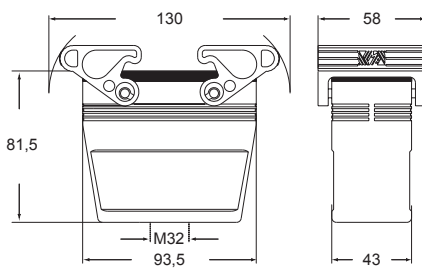

CHCN

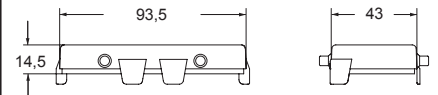

CHCN G

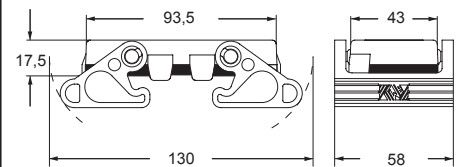

CR LN
Spare part lever for "77.27" enclosures with levers

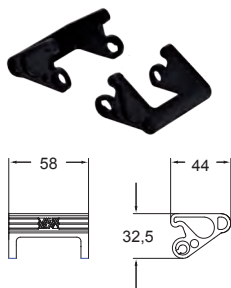

CRUS Type 4/4X/12



For fixing on housings

eyelet

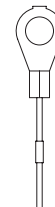

For fixing on hoods

loop

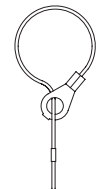

CH..N - MA..N and MH..N - MF..N LS-TYPE version

inserts		page:
CD	64 poles + ⊕	72
CDD	108 poles + ⊕	81
CDS	42 poles + ⊕	-
CDSH	42 poles + ⊕	89
CNE	24 poles + ⊕	113
CSE	24 poles + ⊕	-
CSH	24 poles + ⊕	113
CSH S	24 poles + ⊕	125
CCE	24 poles + ⊕	133
CMSH	10+2 (aux) poles + ⊕	140
CMCE	10+2 (aux) poles + ⊕	141
CSS	24 poles + ⊕	151
CT, CTS (10A) *)	64 poles + ⊕	157
CT, CTSE (16A) *)	24 poles + ⊕	163
CQE	46 poles + ⊕	171
CQEE	64 poles + ⊕	177
CX	4/8 and 6/6 poles + ⊕	204 and 206
MIXO	6 modules	262 - 317

*) only in the CHIN 24 CH and CHIN 24 enclosure

housings with 4 pegs and 2 levers



hoods with 4 pegs



description	part No.	entry M	part No.	entry M
bulkhead mounting housing, with 4 pegs	CHIN 24 CH			
bulkhead mounting housing, with 2 levers	CHIN 24			
surface mounting housing, high construction, with 2 levers	MAPN 24.32	32		
with pegs, side entry			MHON 24.32	32
with pegs, top entry			MHVN 24.32	32
with pegs, side entry, high construction, without adapter ¹⁾			MFON 24.32	32
with pegs, top entry, high construction, without adapter ¹⁾			MFVN 24.32	32

¹⁾ enclosure without adapter, threaded on the enclosure body, to be used only with a complete cable gland.

- kiln powder coating with RAL 9005 black epoxy polyester powder
- RAL 9005 black self-extinguishing thermoplastic locking lever

CHIN CH

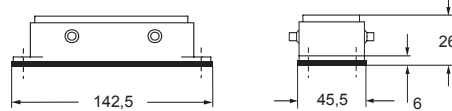

CHIN

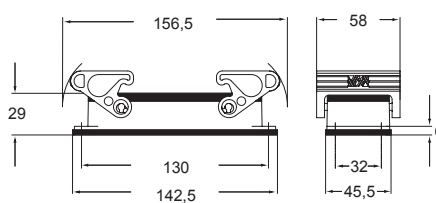

MAPN

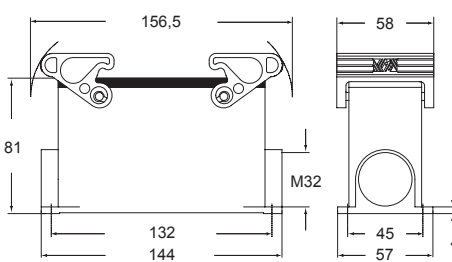

panel cut-out for bulkhead mounting housings CHIN CH and CHIN

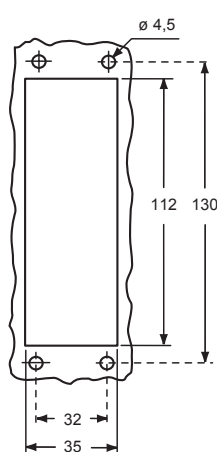

MHON

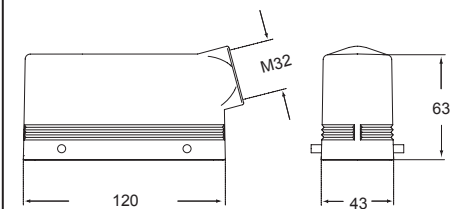

MHVN

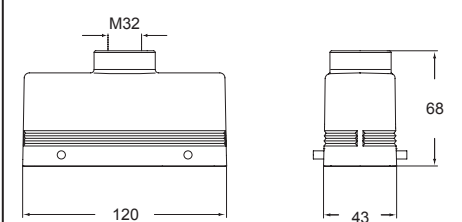

MFON

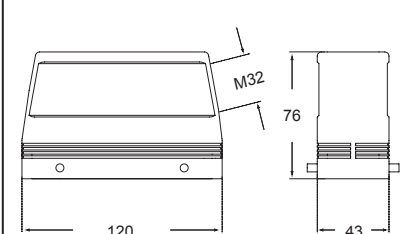

MFVN

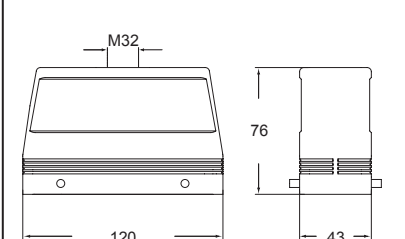

CR LN
Spare part lever for "104.27" enclosures with levers

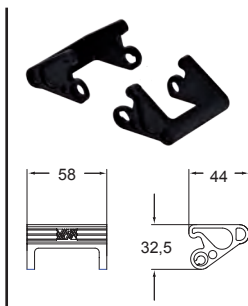

CAIUS Type 4/4X/12



CH..N and MH..N - MF..N LS-TYPE version

inserts		page:
CD	64 poles + ⊕	72
CDD	108 poles + ⊕	81
CDS	42 poles + ⊕	-
CDSH	42 poles + ⊕	89
CNE	24 poles + ⊕	113
CSE	24 poles + ⊕	-
CSH	24 poles + ⊕	113
CSH S	24 poles + ⊕	125
CCE	24 poles + ⊕	133
CMSH	10+2 (aux) poles + ⊕	140
CMCE	10+2 (aux) poles + ⊕	141
CSS	24 poles + ⊕	151
CQE	46 poles + ⊕	171
CQEE	64 poles + ⊕	177
CX	4/8 and 6/6 poles + ⊕	204 and 206
MIXO	6 modules	262 - 317

hoods with 2 levers



covers



description	part No.	entry M	part No. (with eyelet)	part No. (with loop)
-------------	----------	---------	------------------------	----------------------

with levers and gasket, top entry	MHVN 24 G32	32		
with levers and gasket, top entry, high construction, without adapter ¹⁾	MFVN 24 G232	32 x 2		
with levers and gasket, top entry, high construction, without adapter ¹⁾	MFVN 24 G32	32		

covers with pegs
covers with 2 levers

CHCN 24

CHCN 24 G

¹⁾ enclosure without adapter, threaded on the enclosure body, to be used only with a complete cable gland.

- kiln powder coating with RAL 9005 black epoxy polyester powder
- RAL 9005 black self-extinguishing thermoplastic locking lever

MHVN G32

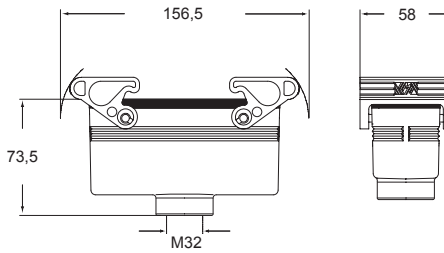

MFVN 24 G232

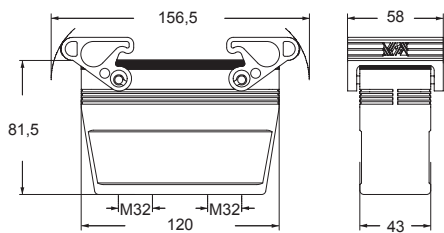

MFVN G32

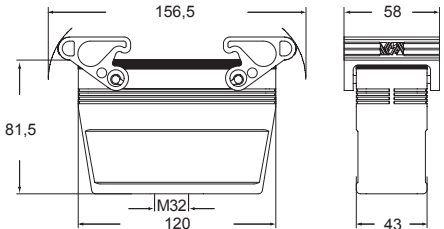

CHCN

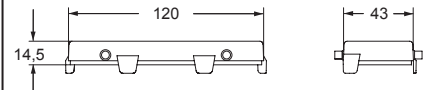

CHCN G

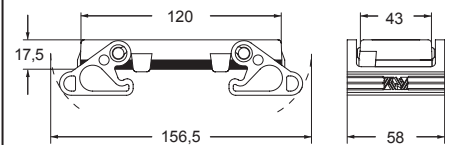

CR LN
Spare part lever for "104.27" enclosures with levers

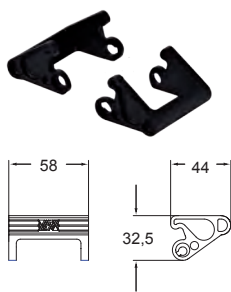

CAIUS Type 4/4X/12



For fixing on housings

eyelet

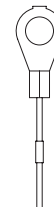

For fixing on hoods

loop

