

BUILD YOUR CONNECTOR

MIXO INSERTS

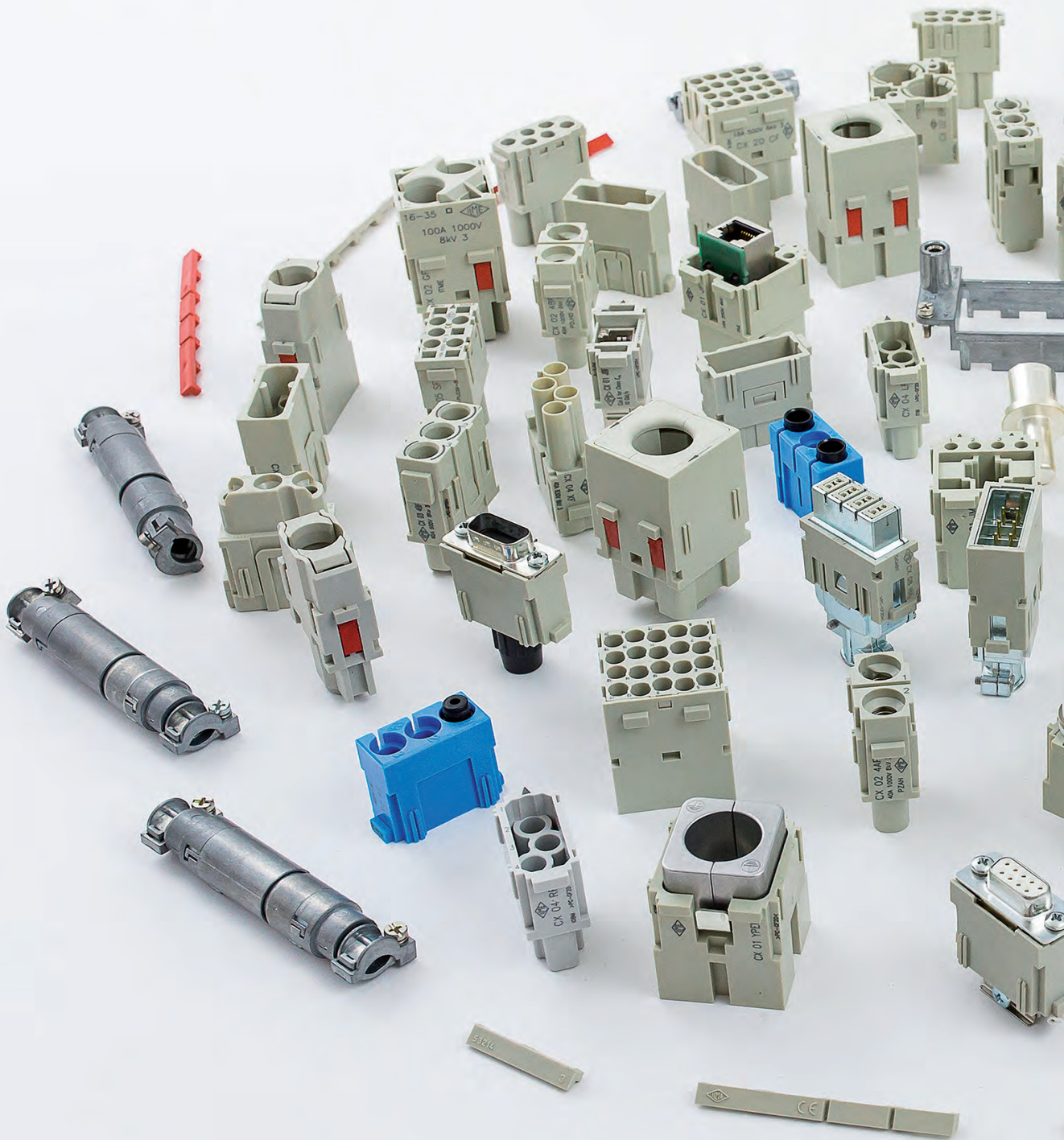



MIXO INSERTS

MIXO SERIES

GENERAL OVERVIEW

The MIXO series is a system of modular units for special applications that uses the traditional ILME enclosures. Each enclosure can house different types of connections such as: electric signals and contacts for the conduction of compressed air with pressure values of up to 8 bars.

The inserts are arranged side by side to form a single **compact block** which is inserted into metallic frames with constrained positioning. Once the modules have been inserted and locked with the special tabs, the connector can be placed into the enclosure.

The modular system makes it easy to access a series of contacts inserted in the frame (e.g., for substitution, check or the addition of signals with new inserts for needs not foreseen during the initial installation) without having to disassemble the entire connector.

ILME MIXO series of modular connectors is an open connector system that provides versatile configuration to the users' individual requirements, giving the **freedom to assemble a customized connector** from a range of over 40 modules for power electrical, data transmission, optical signals or air. The module range is continuously expanded, allowing new configurations to be realised.

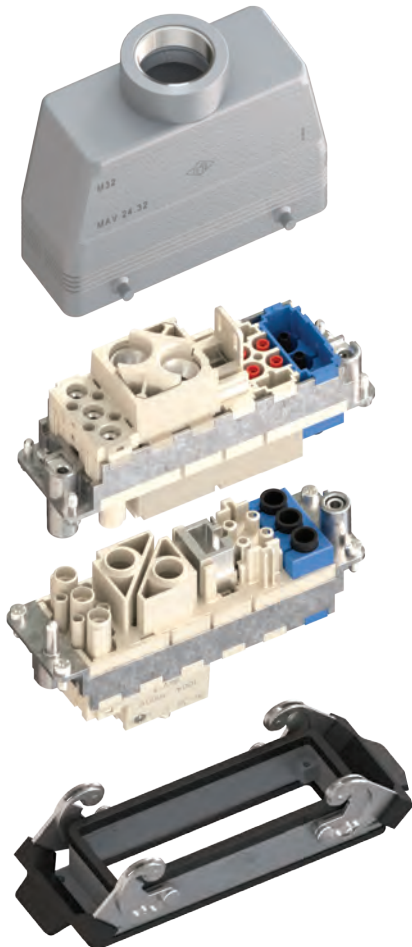

The use of enclosures provides the possibility of innumerable **applications**.

POWER/
SIGNAL



POWER

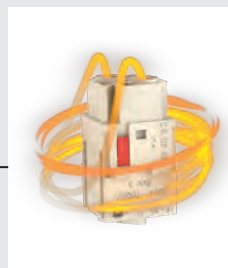

DATA
TRANSMISSION



FIBRE OPTIC



PNEUMATIC



The MIXO series can be used with **5 different frame sizes**:

Frames	one or two-lever metallic enclosures
CX 01 T	size "49.16"
CX 02 TM/TF	size "44.27"
CX 03 TM/TF	size "57.27"
CX 04 TM/TF	size "77.27"
CX 06 TM/TF	size "104.27"
CX 04 TM/TF (x 2)	size "77.62"
CX 06 TM/TF (x 2)	size "104.62"

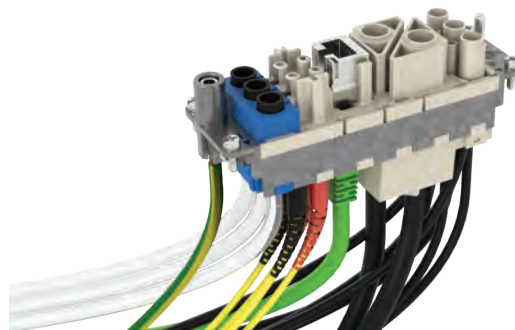

CX 01 T
1 module



CX 02 TF/TM
2 modules

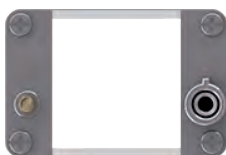

CX 04 TF/TM
4 modules

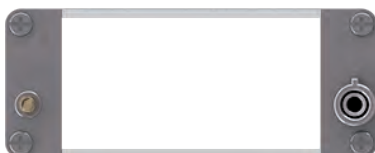

CX 03 TF/TM
3 modules

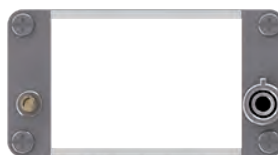

CX 06 TF/TM
6 modules



Possibility – to be verified case-by-case – to use the recently added MIXO **HNM frames** (provided with special gold plated PE contacts) together with R series of crimp contacts and the relevant

connector hoods and housings, to produce, where required, an **HNM connector** (High Number of Matings, up to 10.000 cycles of operation). For more information refer to page 333

Fill the unused frame slots with **CX FM dummy module**



In addition, the MIXO series can be used with the **COB series panel supports**.

Frames	COB panel supports part No.
CX 02 TM/TF	fixed: COB 06 BC and COB TCQ mobile: COB TSF, COB TSFS and COB 06 CMS
CX 03 TM/TF	fixed: COB 10 BC and COB TCQ mobile: COB TSF, COB TSFS and COB 10 CMS

Frames	COB panel supports part No.
CX 04 TM/TF	fixed: COB 16 BC and COB TCQ mobile: COB TSF, COB TSFS and COB 16 CMS
CX 06 TM/TF	fixed: COB 24 BC and COB TCQ mobile: COB TSF, COB TSFS and COB 24 CMS

THE COMPLETE RANGE

Inserts	Contact type	Signal type	Kind of connection	Rated current (A)	Rated voltage (V)	No. of frame slots	HNM suitable
CX 01 YF/M	main	electric	crimp	200	1000	2	—
CX 01 YPEF/M	PE	—	crimp	200	—	2	—
CX 01 GF/M	main	electric	crimp	100	830	1	—
CX 02 GF/M	main	electric	crimp	100	1000	2	—
CX 02 7F/M	main	electric	crimp	70	1000	1	—
CX 02 4AF/M	main	electric	axial screw	40	1000	1	—
CX 02 4BF/M	main	electric	axial screw	40	1000	1	—
CX 02 4F/M	main	electric	crimp	40	1000	1	—
CX 03 4F/M	main	electric	crimp	40	400/690	1	yes
CX 03 4BF/BM	main	electric	crimp	40	500	1	yes
CX 3/4 XDF/M	main / auxiliary	electric	crimp	40/10	830	1	—
CX 04 XF/M	main	electric	crimp	40	830	1	yes
CX 05 SF/M ▲	main	electric	spring	16	400	1	—
CX 05 SHF/M	main	electric	SQUICH®-spring	16	400	1	—
CX 06 CF/M	main	electric	crimp	16	500	1	yes
CX 06P CF/M	main	electric	crimp	16	830	1	yes
CX 08 CF/M	main	electric	crimp	16	400	1	yes
CX 08 I6F/M	main + shield	electric	crimp	5	50	1	—
CX 20 CF/M	main	electric	crimp	16	500	2	yes
CX 12 DF/M	main / auxiliary	electric	crimp	10	250	1	yes
CX 17 DF/M	main / auxiliary	electric	crimp	10	160	1	yes
CX 42 DF/M	main / auxiliary	electric	crimp	10	150	2	yes
CX 25 IBF/M	main / auxiliary	electric	crimp	4	50	1	—
CX 25 IF/M ▲	main / auxiliary	electric	crimp	4	50	1	—
CX 02 CHF/M	main	electric	crimp	16	2500	1	—
CX 02 HF/M	main	electric	crimp	16	2900/5000	2	—
CX 02 BF/M	seat for two shielded connectors (refer to CX 04 B, CX 01 B, CX 01 BC, CX 08 B)					2	—
CX 01 BCF/M	main / auxiliary + shield	electric	crimp	16	50	—	—
CX 01 BF/M	main / auxiliary + shield	electric	crimp	10	50	—	—
CX 04 BF/M	main / auxiliary + shield	electric	crimp	10	50	—	—
CX 08 BF/M	main / auxiliary + shield	electric	crimp	5	50	—	—
CX 03 P	pneumatic Ø 1,6 - 3,0 - 4,0 mm	air	snap-in	—	—	1	—
CX 02 P	pneumatic Ø 6,0 mm	air	snap-in	—	—	1	—
CX FM	none (dummy module)	—	—	—	—	1	yes
CX 01 J8F/M/IM	RJ45	electric	crimp/IDC	—	—	1	—
CX 01 JF/M	RJ45 + auxiliary	electric	crimp	10	250	2	—
CX 02 JF/M	RJ45 + auxiliary	electric	crimp	10	250	3	—
CX 01 UF/M	USB	electric	—	—	—	1	—
CX 01 9VF/M	D-SUB	electric	crimp	5	50	1	—
CX 01 9VTF	D-SUB	electric	screw	5	50	1	—
CX 04 LF/M	POF / MOST	optic	crimp	—	—	1	—
CX 04 RF/M	coaxial	electric	crimp	—	—	1	—
CX 04 SCF/M	SC fibre optic	optic	crimp/glue	—	—	1	—

▲ Available upon request

Calculate the number of frame slots taken up by the required inserts (frame slot 1, 2 or 3 modules) and select the right frame according to the number of required modules (available 1, 2, 3, 4 and 6 modules).



size: 1 frame slot

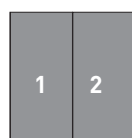

size: 2 frame slots



size: 3 frame slots

THE 41-VARIANT RANGE OF CHOICE

ILME MIXO portfolio includes a series of key modular units being continuously widened:

23 modules	for electric power and signal transmission with contacts for rated current up to:
- 2 module for 200A	with CX 01 YF/YM and CX 01 YPEF/YPEM (for PE connection) (crimp)
- 2 modules for 100A	with CX 02 GF/GM and CX 01 GF/GM (crimp)
- 1 module for 70A	with CX 02 7F/7M (crimp)
- 7 modules for 40A	with CX 02 4F/4M (crimp), CX 02 4AF/4AM and CX 02 4BF/4BM (axial screw), with CX 03 4F/4M and CX 03 4BF/4BM (crimp), CX 3/4 XDF/XDM (crimp), CX 04 XF/XM (crimp)
- 6 modules for 16A	with CX 05 SF/SM ▲ (spring clamp), CX 05 SHF/SHM (SQUICH®), CX 06P CF/CM, CX 06 CF/CM, CX 08 CF/CM, CX 20 CF/CM
- 3 modules for 10A	with CX 12 DF/DM (crimp), CX 17 DF/DM (crimp), CX 42 DF/DM (crimp)
- 2 modules for 4A	with CX 25 IF/IM ▲ and CX 25 IBF/IBM (crimp)
2 modules	for high voltage connections 16A – 2,9/5,0 kV with CX 02 HF/HM and 2,5 kV with CX 02 CHF/ CHM
4 MIXO-BUS	shielded connectors for bus data transmission:
- 1 module CX 02 BF/BM	for two shielded connectors to be chosen among the following 4 options:
1. CX 01 BF/BM	coaxial, 10A (crimp) – 75 Ω characteristic impedance
2. CX 01 BCF/BCM	coaxial, 16A (crimp) – 50 Ω characteristic impedance
3. CX 04 BF/BM	quad-axial 10A (crimp)
4. CX 08 BF/BM	8-ways 5A (crimp)
3 modules/adapters	for RJ-45:
- CX 01 J8F/J8M/J8IM	single-sized module for 1 RJ-45 patch cord, female module is a “gender changer”
- CX 01 JF/JM	double-sized module for 1 RJ-45 patch cord + 4 auxiliary 10A (crimp) contacts
- CX 02 JF/JM	triple-sized module for 2 RJ-45 patch cords + 8 auxiliary 10A (crimp) contacts
1 module	for Gigabit Ethernet , with CX 08 I6F/ I6M, 5A (crimp) and relevant accessories
1 module/adapter	for USB:
	male adapter for USB patch cord
	female adapter is a F/F “gender changer”, for rear connection to a male USB patch cord with CX 01 UF/UM
2 modules	with D-Sub 9-pole with CX 01 9VF/9VM, 5A (crimp) and CX 01 9VTF (for RS-485 T-connection)
2 modules	for pneumatic quick-couplings with CX 02 P and CX 03 P
3 modules	for fibre optic (POF or MOST® or SC) or coaxial crimp contacts (50 Ω or 75 Ω characteristic impedance) with CX 04 LF/LM, CX 04 RF/RM and CX 04 SCF/SCM

In addition to:

- 5 frames** for the build-up of a modular connector.
The connector consists of a multiple number of the above listed single-sized and/or double-sized modular units and/or triple-sized modules; 4 +1 frames in particular fit the main housing sizes:
- “44.27” for 2 single-sized modules or 1 double-sized module;
 - “57.27” for 3 single-sized modules or a combination of 1 single-sized module or 1 double-sized module, or 1 triple-sized module;
 - “77.27” for 4 single-sized modules, 2 double-sized modules, 1 triple-sized module and 1 single-sized module, or a combination of 2 single-sized modules or 1 double-sized module;
 - “104.27” for 6 single-sized modules, 4 single-sized modules and 1 double-sized module, 2 single-sized modules and 2 double-sized modules, 3 double-sized modules, 2 triple-sized modules, 1 triple-sized module and 1 double-sized module and 1 single-sized module, or 1 triple-sized module and 3 single-sized modules.

1 frame for the build-up of 1 single-sized module in connector housings size “49.16”.

The frame range allows the build-up of 7 different sizes of multipole modular connectors (this because 2 frames each of sizes “77.27” and “104.27” may be additionally combined in the double-sized “77.62” and “104.62” connector housings).



TECHNICAL CHARACTERISTICS

- 1 Pneumatic contacts in plastic with hose barb connection.
- 2 Fibre optic contacts SC type.
- 3 Electric contacts in silver-plated or gold-plated brass with connections to the conductors via crimping, spring clamp or axial screw.
- 4 Modular inserts of identical size with insertion system for forming the complete module and frame lock tab.
- 5 Inserts in self-extinguishing thermoplastic material, reinforced with glass fibre, UL 94V-0 approved, with a working temperature range of -40 °C to +125 °C.
- 6 Inserts in conformance with the requirements of the EN 61984 standard and certified and marked with the UL, CSA, CQC, DNV-GL, BV, EAC marks.
- 7 Inserts with patented "swallowtails" to prevent incorrect coupling.
- 8 Position of contacts identified with numbers or codes on both sides of every insert.
- 9 Male/female module carrier frames with mandatory housings and polarity, in die-cast zinc alloy.
- 10 Module lock tab, may be divided according to the number of modules used; it guarantees a perfect stability of the modules during wiring and coupling/uncoupling of the connectors.
- 11 Asymmetric protective earth contacts (two per frame) with wide contact surface to prevent incorrect coupling; when two or more identical connectors of the MIXO series are used, coded pins may prevent incorrect coupling (refer to pages 684, 685 and 689).
- 12 Captive frame fastening screws, with spring washer.
- 13 Dummy module for unused frame slots.

ADVANTAGES

- ☐ Easy and user-friendly assembly of the complete multi-module insert before fixing it on the relevant sized metal frame;
- ☐ use of proprietary ILME technology providing each module with "swallowtails" (lateral keys/keyways), for reciprocal locking of modules and overall assembly of the insert into rigid (non hinged) frames with snap-in locking strips;
- ☐ faster and easier assembly compared with competitor solutions (easier handling of modules as a complete block than e.g. 6 independent parts);
- ☐ intermateability at "complete connector" (modules in frame) with other industry standard products;
- ☐ robust and long lasting prevailing crimp connection technology (largely preferred over screw type technology in high vibration and shock environments).

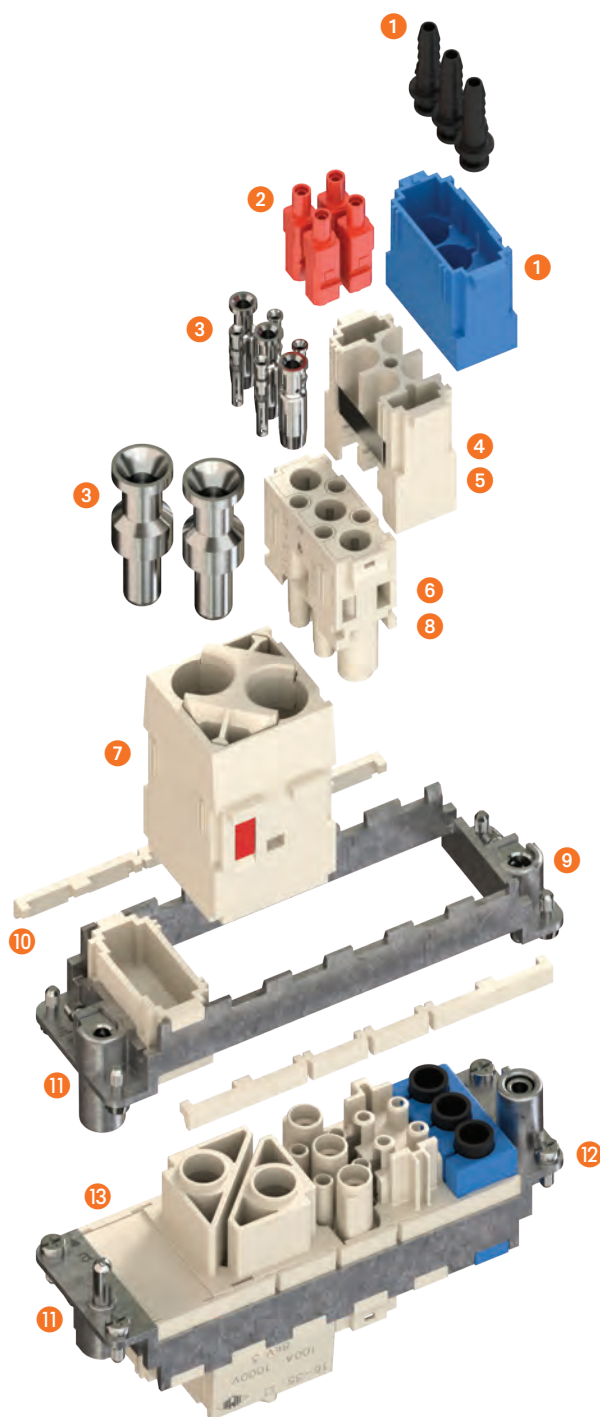

Watch our
MIXO & MATCH
video

CX 01 YF/YM 1 pole 200A - 1000V

The modular inserts must be installed in suitable frames, which are then mounted in traditional enclosures* or in COB panel supports.

frames for modular units*

page: 317

modular units, crimp connections



200A silver plated crimp contacts heat shrink tube

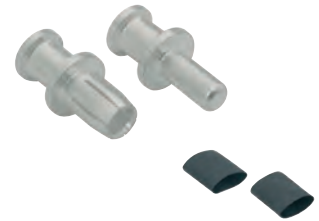

* enclosures: housings or high construction hoods

description	part No.	part No.
-------------	----------	----------

without contacts (to be ordered separately)
female inserts for female contacts
male inserts for male contacts

CX 01 YF
CX 01 YM

200A female crimp contacts
16 mm² AWG 6 one groove (back side)
25 mm² AWG 4 with no grooves
35 mm² AWG 2 one groove
50 mm² AWG 1 two grooves
70 mm² AWG 2/0 with no grooves

CYFA 16
CYFA 25
CYFA 35
CYFA 50
CYFA 70

silver plated

200A male crimp contacts
16 mm² AWG 6 one groove (back side)
25 mm² AWG 4 with no grooves
35 mm² AWG 2 one groove
50 mm² AWG 1 two grooves
70 mm² AWG 2/0 with no grooves

CYMA 16
CYMA 25
CYMA 35
CYMA 50
CYMA 70

heat shrink tube for CYFA/CYMA 16 contacts or for conductor with total external Ø < 10 mm

CR TT

- characteristics according to EN 61984:

200A 1000V 8kV 3
200A 920/1600V 8kV 2

- cULus (UL for USA and Canada), SIB, CEC, DNV-GL

- Bureau Veritas ERI certified
- rated voltage according to UL/CSA: 600V
- insulation resistance: ≥ 10 GΩ
- ambient temperature limit: -40 °C ... +125 °C
- made of self-extinguishing thermoplastic resin UL 94V-0
- mechanical life: ≥ 500 cycles
- contact resistance: ≤ 0,2 mΩ
- **it is recommended to crimp the contacts with crimping tools homologated by ILME** (please see the crimping tool section 200A contacts, CYF and CYM series) on pages 708 - 741
- for max. current load see the connector inserts derating diagram below; for more information see page 28

CX 01 Y, 1 pole connector inserts (MIXO 200A)
Maximum current load derating diagram

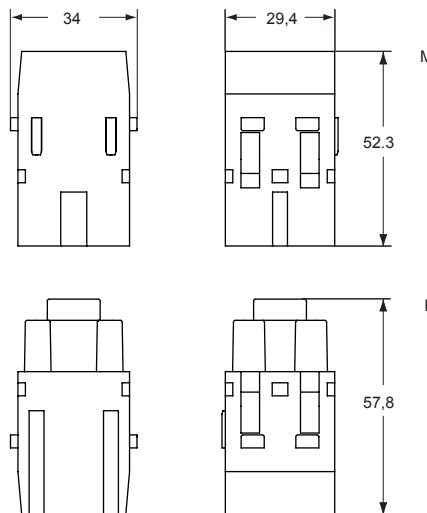
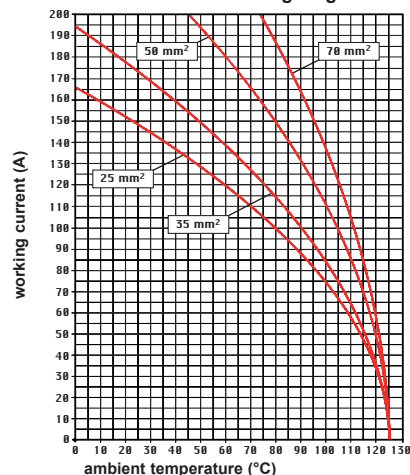

contacts side (front view)

side with reference arrow ▲

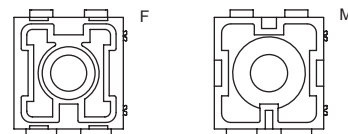

- 2 frame slots

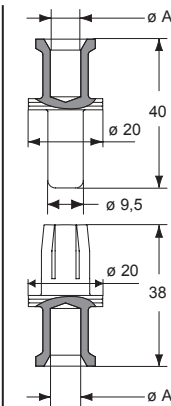

CYF and CYM contacts

conductor section (mm ²)	conductor slot (mm)	conductor stripping length (mm)
16	6,1	15
25	7,0	15
35	8,2	15
50	9,8	15
70	11,8	15

CX 01 YPEF/YPEM 1 PE pole 200A

The modular inserts must be installed in suitable frames, which are then mounted in traditional enclosures* or in COB panel supports.

frames for modular units*

page:
317

modular units, crimp connections
PE module for earth termination



200A silver plated crimp contacts



* enclosures: housings or high construction hoods

description	part No.	part No
-------------	----------	---------

without contacts (to be ordered separately)
PE female inserts for female contacts
PE male inserts for male contacts

CX 01 YPEF
CX 01 YPEM

200A female crimp contacts

16 mm ²	AWG 6	one groove (back side)
25 mm ²	AWG 4	with no grooves
35 mm ²	AWG 2	one groove
50 mm ²	AWG 1	two grooves
70 mm ²	AWG 2/0	with no grooves

CYFA 16
CYFA 25
CYFA 35
CYFA 50
CYFA 70

silver plated

200A male crimp contacts

16 mm ²	AWG 6	one groove (back side)
25 mm ²	AWG 4	with no grooves
35 mm ²	AWG 2	one groove
50 mm ²	AWG 1	two grooves
70 mm ²	AWG 2/0	with no grooves

CYMA 16
CYMA 25
CYMA 35
CYMA 50
CYMA 70

- cULus (UL for USA and Canada), SB, ccc, DNV-GL
- EAC certified
- ambient temperature limit: -40 °C ... +125 °C
- made of self-extinguishing thermoplastic resin UL 94V-0
- mechanical life: ≥ 500 cycles
- contact resistance: ≤ 0,2 mΩ
- **it is recommended to crimp the contacts with crimping tools homologated by ILME** (please see the crimping tool section 200A contacts, CYF and CYM series) on pages 708 - 741

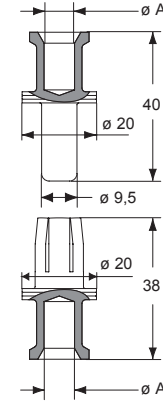
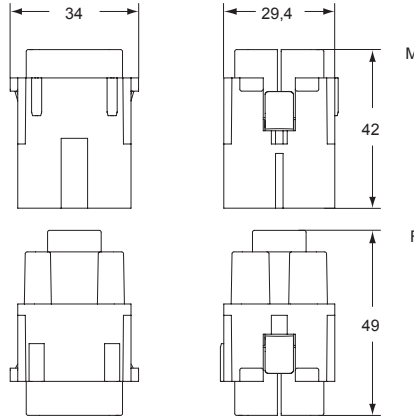

contacts side (front view)

side with reference arrow ▲

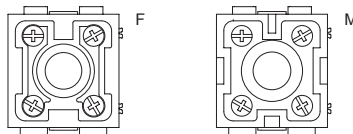

- 2 frame slots

CYF and CYM contacts

conductor section ø A (mm ²)	conductor slot (mm)	conductor stripping length (mm)
16	6,1	15
25	7,0	15
35	8,2	15
50	9,8	15
70	11,8	15

CX 01 GF/GM 1 pole 100A - 830V

The modular inserts must be installed in suitable frames which are then mounted in traditional enclosures* or in COB panel support.
Single-sized modular units may be directly mounted inside MIXO ONE enclosures.

frames for modular units* page: 316 - 317

MIXO ONE enclosures 369

* enclosures: bulkhead mounting housings, high construction housings or high construction hoods

modular units,
crimp connections

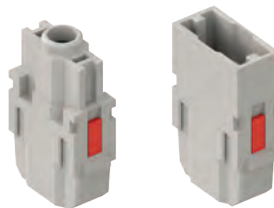

100A silver plated crimp contacts,
PE adapter



description

part No.

part No.

without contacts (to be ordered separately)

female inserts for female contacts

male inserts for male contacts

CX 01 GF
CX 01 GM

100A female crimp contacts

8-10 mm² AWG 8-7

16 mm² AWG 6-5

25 mm² AWG 4-3

35 mm² AWG 2

CGFA 10
CGFA 16
CGFA 25
CGFA 35

silver plated

100A male crimp contacts

8-10 mm² AWG 8-7

16 mm² AWG 6-5

25 mm² AWG 4-3

35 mm² AWG 2

CGMA 10
CGMA 16
CGMA 25
CGMA 35

cable earthing adapter 16 mm² (AWG 6-5)

CGT 16

- characteristics according to EN 61984:

100A 830V 8kV 3

- certified
- rated voltage according to UL/CSA: 600V
- insulation resistance: $\geq 10 \text{ G}\Omega$
- ambient temperature limit: $-40 \text{ }^\circ\text{C} \dots +125 \text{ }^\circ\text{C}$
- made of self-extinguishing thermoplastic resin UL 94V-0
- mechanical life: ≥ 500 cycles
- contact resistance: $\leq 0,3 \text{ m}\Omega$
- **it is recommended to crimp the contacts with crimping tools homologated by ILME** (please see the crimping tool section 100A contacts, CGF and CGM series) on pages 708 - 741
- contact removal only using a screwdriver
- for max. current load see the connector inserts derating diagram below; for more information see page 28

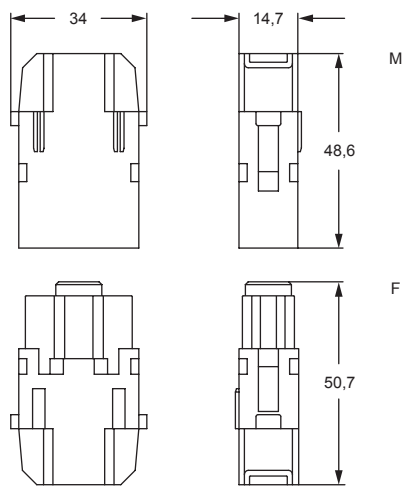

contacts side (front view)

side with reference arrow ▲

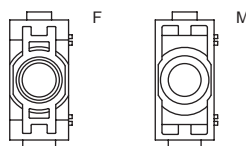

- 1 frame slot

CGF and CGM

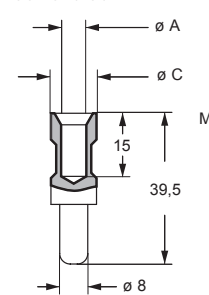

CGT 16

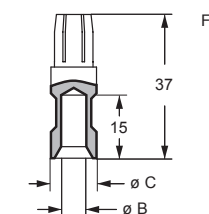
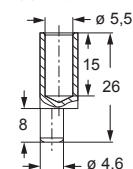

CGF and CGM contacts

conductor section (mm ²)	conductor diameter (mm)	conductor slot diameter (mm)	conductor diameter (mm)	conductor stripping length (mm)
8-10	4,3	4,3	13	15
16	5,5	5,5	13	15
25	7,0	7,0	13	15
35	7,9	8,2	12,5	15

How to use the PE adapter (CGT 16):

- 1) Strip 15 mm of flexible PE protective cable
- 2) Crimp the cable on the CGT 16 adapter by using the CGPZ pliers with the CGD 16 C matrix
- 3) Fix the adapter tip in the larger earth terminal (6 mm²) of frames CX...TM/TF
- 4) To be used with bulkhead mounting housings or high construction hoods
- 5) Cannot be used with T-TYPE series

CX 01 G, 1 pole connector inserts
Maximum current load derating diagram

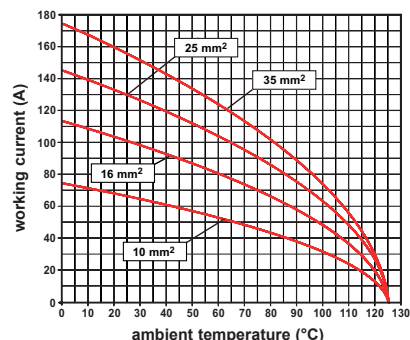

Watch our online tutorial

CX 02 GF/GM 2 poles 100A - 1000V

The modular inserts must be installed in suitable frames, which are then mounted in traditional enclosures* or in COB panel supports.

frames for modular units*

page:
317

modular units,
crimp connections

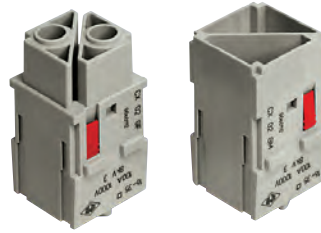

100A silver plated crimp contacts,
PE adapter



* enclosures: bulkhead mounting housings, high construction housings or high construction hoods

description	part No.	part No.
without contacts (to be ordered separately)		
female inserts for female contacts ¹⁾	CX 02 GF	
male inserts for male contacts ¹⁾	CX 02 GM	
100A female crimp contacts		CGFA 10
8-10 mm ² AWG 8-7		CGFA 16
16 mm ² AWG 6-5		CGFA 25
25 mm ² AWG 4-3		CGFA 35
35 mm ² AWG 2		
100A male crimp contacts		CGMA 10
8-10 mm ² AWG 8-7		CGMA 16
16 mm ² AWG 6-5		CGMA 25
25 mm ² AWG 4-3		CGMA 35
35 mm ² AWG 2		
cable earthing adapter 16 mm ² (AWG 6-5)		CGT 16

silver plated

¹⁾ on request, version with pole 3/4 numbering, references: **CX 02 GFN, CX 02 GMN**

- characteristics according to EN 61984:

100A 1000V 8kV 3
100A 920/1600V 8kV 2

- cULus (UL for USA and Canada),

ERC certified

- rated voltage according to UL/CSA: 600V

- insulation resistance: $\geq 10 \text{ G}\Omega$

- ambient temperature limit: -40 °C ... +125 °C

- made of self-extinguishing thermoplastic resin UL 94V-0

- mechanical life: ≥ 500 cycles

- contact resistance: $\leq 0,3 \text{ m}\Omega$

- **it is recommended to crimp the contacts with crimping tools homologated by ILME** (please see the crimping tool section 100A contacts, CGF and CGM series) on pages 708 - 741

- for max. current load see the connector inserts derating diagram below; for more information see page 28

CX 02 G, 2 poles connector inserts
Maximum current load derating diagram

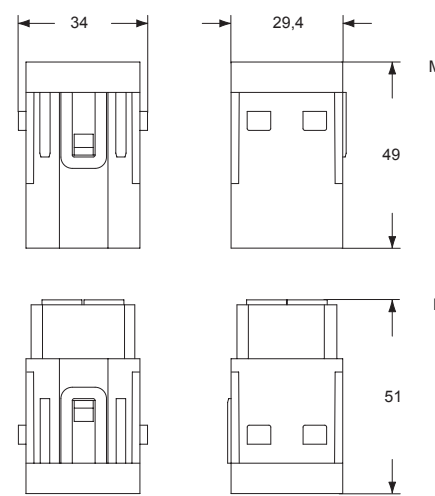
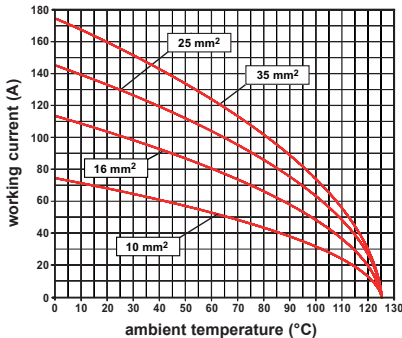

contacts side (front view)

side with reference arrow ▲

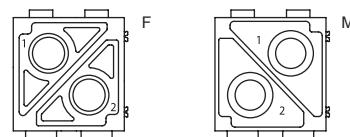

- 2 frame slots

CGF and CGM

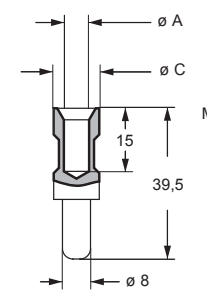

CGT 16

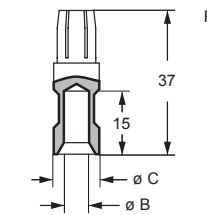
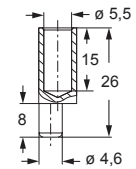

CGF and CGM contacts

conductor section (mm ²)	conductor slot ø A (mm)	conductor slot ø B (mm)	conductor slot ø C (mm)	conductor stripping length (mm)
8-10	4,3	4,3	13	15
16	5,5	5,5	13	15
25	7,0	7,0	13	15
35	7,9	8,2	12,5	15

How to use the PE adapter (CGT 16):

- Strip 15 mm of flexible PE protective cable
- Crimp the cable on the CGT 16 adapter by using the CGPZ pliers with the CGD 16 C matrix
- Fix the adapter tip in the larger earth terminal (6 mm²) of frames CX...TM/TF
- To be used with bulkhead mounting housings or high construction hoods
- Cannot be used with T-TYPE series

CX 02 7F/7M 2 poles 70A - 1000V

The modular inserts must be installed in suitable frames which are then mounted in traditional enclosures* or in COB panel support.
Single-sized modular units may be directly mounted inside MIXO ONE enclosures.

frames for modular units* page: 317
MIXO ONE enclosures 369

* enclosures: bulkhead mounting housings, high construction housings or high construction hoods

modular units, crimp connections



70A silver plated crimp contacts



description	part No.	part No.
-------------	----------	----------

without contacts (to be ordered separately)		
female inserts for female contacts	CX 02 7F	
male inserts for male contacts	CX 02 7M	
70A female crimp contacts		CX7FA 10
10 mm ² AWG 8 - 7		CX7FA 16
16 mm ² AWG 6 - 5		CX7FA 25
25 mm ² AWG 4 - 3		
70A male crimp contacts		CX7MA 10
10 mm ² AWG 8 - 7		CX7MA 16
16 mm ² AWG 6 - 5		CX7MA 25
25 mm ² AWG 4 - 3		

silver plated

MIXO INSERTS

- characteristics according to EN 61984:
- 70A 1000V 8kV 3**
- 70A 1600V 12kV 2**
- (UL for USA and Canada), certified
- rated voltage according to UL/CSA: 600V
- insulation resistance: ≥ 10 GΩ
- ambient temperature limit: -40 °C ... +125 °C
- made of self-extinguishing thermoplastic resin UL 94V-0
- mechanical life: ≥ 500 cycles
- contact resistance: ≤ 0,5 mΩ
- **it is recommended to crimp the contacts with crimping tools homologated by ILME** (please see the crimping tool section 70A contacts, CX7F and CX7M series) on pages 708 - 741
- **C7ES** removal tool
- for max. current load see the connector inserts derating diagram below; for more information see page 28

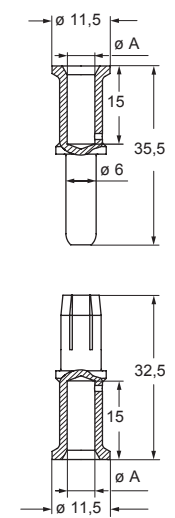
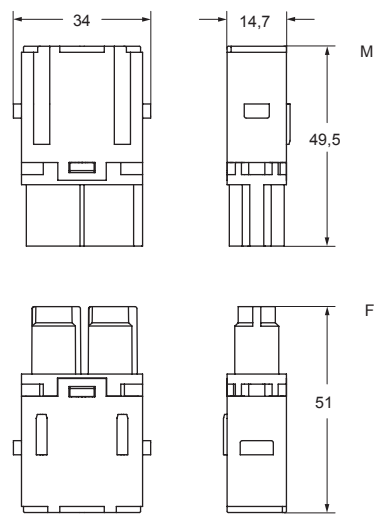

CX7F and CX7M contacts

conductor section (mm ²)	conductor slot ø A (mm)	conductor stripping length (mm)
10	4,3	15
16	5,5	15
25	7,0	15

CX 02 7, 2 poles connector inserts
Maximum current load derating diagram

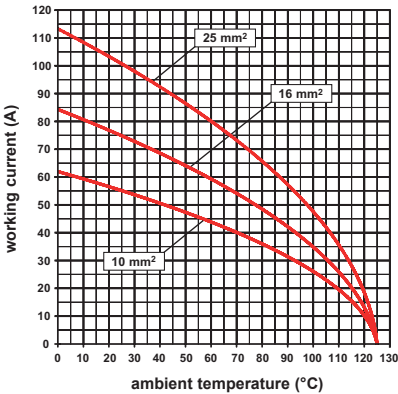

contacts side (front view)

side with reference arrow ▲

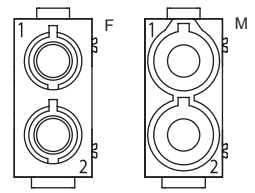

- 1 frame slot

CX 02 4F/4M 2 poles 40A - 1000V

The modular inserts must be installed in suitable frames which are then mounted in traditional enclosures* or in COB panel support.
Single-sized modular units may be directly mounted inside MIXO ONE enclosures.

frames for modular units* page: 316 - 317
MIXO ONE enclosures 369

* enclosures: bulkhead mounting housings, high construction housings or high construction hoods

modular units, crimp connections

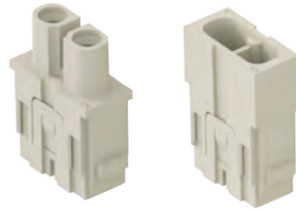

40A silver plated crimp contacts



description	part No.	part No.
-------------	----------	----------

without contacts (to be ordered separately)
female inserts for female contacts ¹⁾
male inserts for male contacts ¹⁾

CX 02 4F
CX 02 4M

40A female crimp contacts
1,5 mm² AWG 16
2,5 mm² AWG 14
4 mm² AWG 12
6 mm² AWG 10
10 mm² AWG 8

CXFA 1.5
CXFA 2.5
CXFA 4.0
CXFA 6.0
CXFA 10

silver plated

40A male crimp contacts
1,5 mm² AWG 16
2,5 mm² AWG 14
4 mm² AWG 12
6 mm² AWG 10
10 mm² AWG 8

CXMA 1.5
CXMA 2.5
CXMA 4.0
CXMA 6.0
CXMA 10

¹⁾ cable diameter up to 7,5 mm
contact size up to 10 mm²

- characteristics according to EN 61984:
40A 1000V 8kV 3

- certified
- rated voltage according to UL/CSA: 600V
- insulation resistance: ≥ 10 GΩ
- ambient temperature limit: -40 °C ... +125 °C
- made of self-extinguishing thermoplastic resin UL 94V-0
- mechanical life: ≥ 500 cycles
- contact resistance: ≤ 0,3 mΩ
- can be mated with CX 02 4A/4B modules
- **it is recommended to crimp the contacts** (1,5 - 10 mm²), **with crimping tools homologated by ILME** (please see the crimping tool section 40A contacts, CXF and CXM series) on pages 708 - 741
- for max. current load see the connector inserts derating diagram below; for more information see page 28

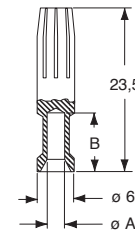
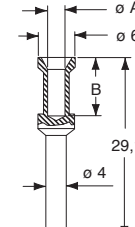
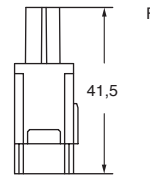
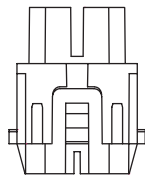
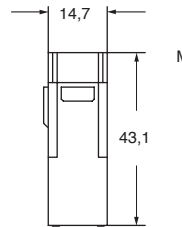
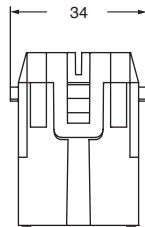

contacts side (front view)

side with reference arrow ▲

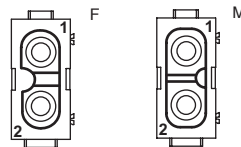

- 1 frame slot

CX 02 4, 2 poles connector inserts
Maximum current load derating diagram

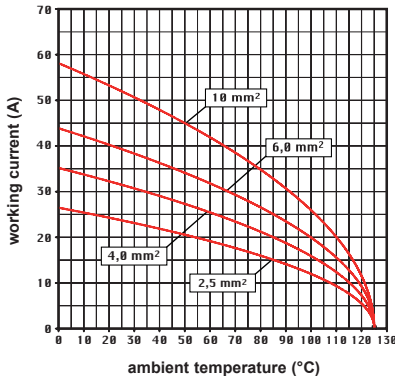

CXF and CXM contacts

conductor section (mm ²)	conductor slot ø A (mm)	conductor stripping length B (mm)
1,5	1,8	9
2,5	2,2	9
4	2,85	9,6
6	3,5	9,6
10	4,3	15

CX 02 4AF/4AM - CX 02 4BF/4BM 2 poles 40A - 1000V

The modular inserts must be installed in suitable frames which are then mounted in traditional enclosures or in COB panel support.
Single-sized modular units may be directly mounted inside MIXO ONE enclosures.

frames for modular units page:
316 - 317

MIXO ONE enclosures 369

modular units,
screw terminal connection
2,5 - 8 mm²

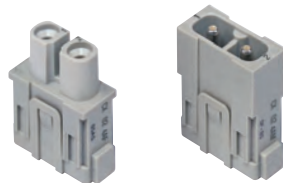

modular units,
screw terminal connection
6 - 10 mm²



description

part No.

part No

female inserts with female contacts
male inserts with male contacts

CX 02 4AF
CX 02 4AM

female inserts with female contacts
male inserts with male contacts

CX 02 4BF
CX 02 4BM

- use flexible cables with sections from 2,5 to 10 mm² or extra flexible cables with sections from 2,5 to 6 mm²
- do not twist the cables
- fully insert the braids in the rear section of the contact

conductor section (mm ²)	conductor stripping length (mm)	tightening torque (Nm)
2,5	5+1	1,5
4	5+1	1,5
6	8+1	2
10	8+1	2

- insert a 2 mm hexagonal key in the front section of the contact and tighten by keeping the cable held down in position
- a 2 mm hexagonal key can be supplied on request, reference **CX AS**



- characteristics according to EN 61984:

40A 1000V 8kV 3
40A 1600V 12kV 2

- certified
- rated voltage according to UL/CSA: 600V
- insulation resistance: ≥ 10 GΩ
- ambient temperature limit: -40 °C ... +125 °C
- made of self-extinguishing thermoplastic resin UL 94V-0
- mechanical life: ≥ 500 cycles
- contact resistance: ≤ 0,5 mΩ
- for max. current load see the connector inserts derating diagram below; for more information see page 28

CX 02 4A/B, 2 poles connector inserts
Maximum current load derating diagram

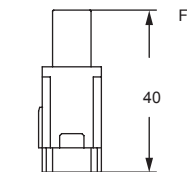
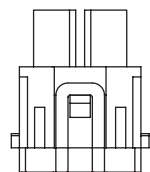
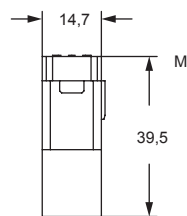
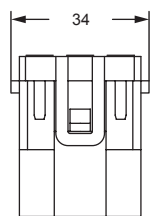
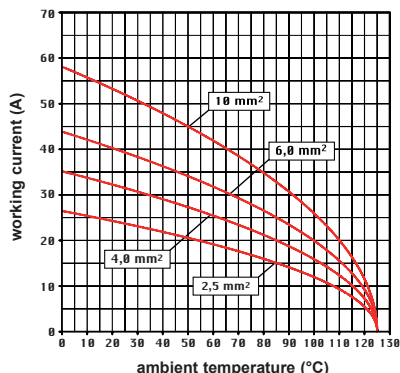

contacts side (front view)

side with reference arrow ▲

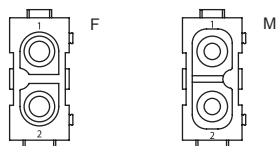

- inserts for Ø 4mm cables, section: 2,5-8 mm² - AWG 14-8
- 1 frame slot

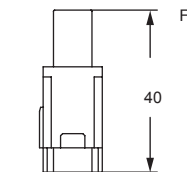
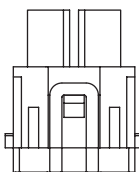
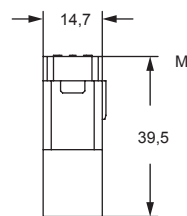
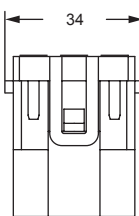

contacts side (front view)

side with reference arrow ▲

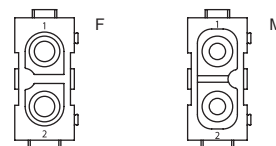

- inserts for Ø 4,8 mm cables, section: 6-10 mm² - AWG 10-8
- 1 frame slot

CX 03 4F/4M 3 poles 40A - 400/690V

The modular inserts must be installed in suitable frames which are then mounted in traditional enclosures or in COB panel support.
Single-sized modular units may be directly mounted inside MIXO ONE enclosures.

frames for modular units page: 316 - 317
MIXO ONE enclosures 369

modular units, crimp connections

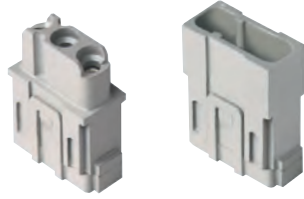

40A silver plated crimp contacts



description	part No.	part No.
-------------	----------	----------

without contacts (to be ordered separately)
female inserts for female contacts ¹⁾ **CX 03 4F**
male inserts for male contacts ¹⁾ **CX 03 4M**

40A female crimp contacts
1,5 mm² AWG 16
2,5 mm² AWG 14
4 mm² AWG 12
6 mm² AWG 10

CXFA 1.5
CXFA 2.5
CXFA 4.0
CXFA 6.0

silver plated

40A male crimp contacts
1,5 mm² AWG 16
2,5 mm² AWG 14
4 mm² AWG 12
6 mm² AWG 10

CXMA 1.5
CXMA 2.5
CXMA 4.0
CXMA 6.0

¹⁾ cable diameter up to 5 mm

- characteristics according to EN 61984:
40A 400/690V 6kV 3
- certified
- rated voltage according to UL/CSA: 600V
- insulation resistance: ≥ 10 GΩ
- ambient temperature limit: -40 °C ... +125 °C
- made of self-extinguishing thermoplastic resin UL 94V-0
- mechanical life: ≥ 500 cycles
- contact resistance: ≤ 0,3 mΩ
- **it is recommended to crimp the contacts with crimping tools homologated by ILME** (please see the crimping tool section 40A contacts, CXF and CXM series) on pages 708 - 741
- for max. current load see the connector inserts derating diagram below; for more information see page 28

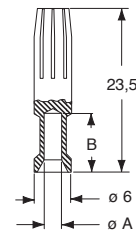
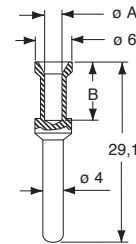
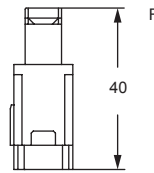
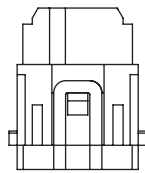
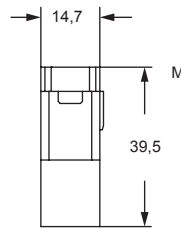
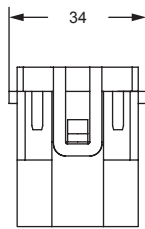

contacts side (front view)

side with reference arrow ▲

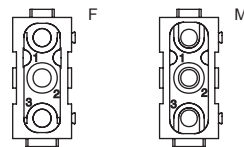

- 1 frame slot

CXF and CXM contacts

conductor section (mm ²)	conductor slot ø A (mm)	conductor stripping length B (mm)
1,5	1,8	9
2,5	2,2	9
4	2,85	9,6
6	3,5	9,6

CX 03 4, 3 poles connector inserts
Maximum current load derating diagram

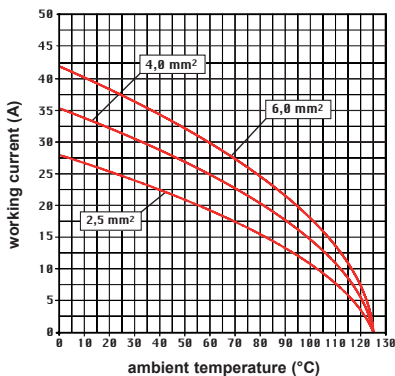

CX 03 4BF/4BM 3 poles 40A - 500V

The modular inserts must be installed in suitable frames which are then mounted in traditional enclosures* or in COB panel support.

Single-sized modular units may be directly mounted inside MIXO ONE enclosures.

frames for modular units* page: 316 - 317

MIXO ONE enclosures 369

* enclosures: bulkhead mounting housings, high construction housings or high construction hoods

modular units, crimp connections

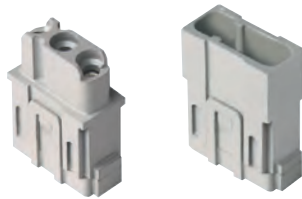

40A silver plated crimp contacts



description

part No.

part No.

without contacts (to be ordered separately)
female inserts for female contacts ¹⁾
male inserts for male contacts ¹⁾

CX 03 4BF
CX 03 4BM

40A female crimp contacts

1,5 mm ²	AWG 16
2,5 mm ²	AWG 14
4 mm ²	AWG 12
6 mm ²	AWG 10
10 mm ²	AWG 8

40A male crimp contacts

1,5 mm ²	AWG 16
2,5 mm ²	AWG 14
4 mm ²	AWG 12
6 mm ²	AWG 10
10 mm ²	AWG 8

CXFA 1.5
CXFA 2.5
CXFA 4.0
CXFA 6.0
CXFA 10

silver plated

CXMA 1.5
CXMA 2.5
CXMA 4.0
CXMA 6.0
CXMA 10

¹⁾ cable diameter up to 7,5 mm
contact size up to 10 mm²

- characteristics according to EN 61984:

40A 500V 6kV 3

- cULus (UL for USA and Canada),

- certified

- rated voltage according to UL/CSA: 600V

- insulation resistance: $\geq 10 \text{ G}\Omega$

- ambient temperature limit: -40 °C ... +125 °C

- made of self-extinguishing thermoplastic resin UL 94V-0

- mechanical life: ≥ 500 cycles

- contact resistance: $\leq 0,3 \text{ m}\Omega$

- **it is recommended to crimp the contacts** (1,5 - 10 mm²), **with crimping tools homologated by ILME** (please see the crimping tool section 40A contacts, CXF and CXM series) on pages 708 - 741

- for max. current load see the connector inserts derating diagram below; for more information see page 28

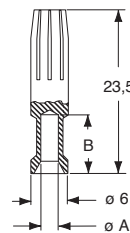
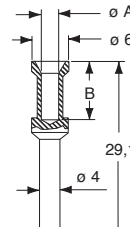
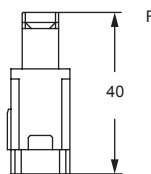
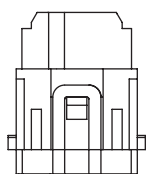
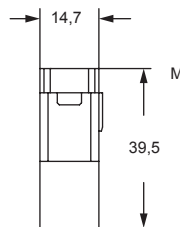
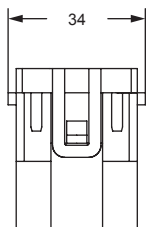

contacts side (front view)

side with reference arrow ▲

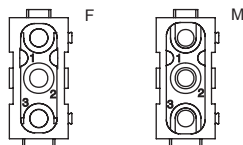

- 1 frame slot

CX 03 4B, 3 poles connector inserts
Maximum current load derating diagram

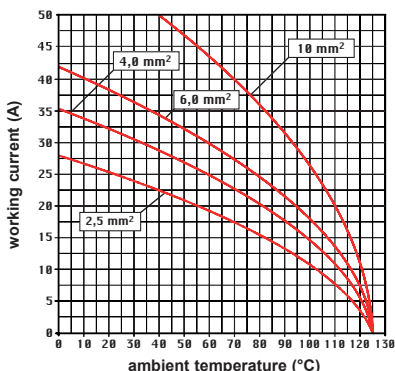

CXF and CXM contacts

conductor section (mm ²)	conductor slot ø A (mm)	conductor stripping length B (mm)
1,5	1,8	9
2,5	2,2	9
4	2,85	9,6
6	3,5	9,6
10	4,3	15

CX 3/4 XDF/XDM 3 poles (40A - 830V) + 4 poles (10A - 830V)

The modular inserts must be installed in suitable frames which are then mounted in traditional enclosures or in COB panel support. Single-sized modular units may be directly mounted inside MIXO ONE enclosures.

page:

frames for modular units 316 - 317
MIXO ONE enclosures 369

- male and female contacts finger proof
- their key characteristic lies in the fact that they guarantee maximum safety even in case of accidental contact with fingers (IP2X or IPXXB). Safety is guaranteed as standard on female contacts, but also on male contacts. This feature is important as it ensures full compliance with the recent safety standard EN 60204-1, concerning electric equipment fitted on machines and in particular with the requirements of Article 6.2.4 concerning protection against residual voltage. In the case of plugs or similar devices, the withdrawal of which results in the exposure of conductors (for example pins), the discharge time shall not exceed 1 s, otherwise such conductors shall be protected against direct contact to at least an IP2X or IPXXB.

modular units, crimp connections

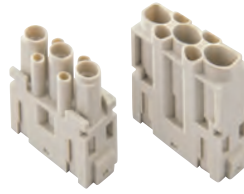

40A and 10A crimp contacts silver and gold plated



description	part No.	part No.	part No.
without contacts (to be ordered separately)			
female inserts for female contacts	CX 3/4 XDF		
male inserts for male contacts	CX 3/4 XDM		
40A female crimp contacts		CXFA 1.5	
1,5 mm ² AWG 16		CXFA 2.5	
2,5 mm ² AWG 14		CXFA 4.0	
4 mm ² AWG 12		CXFA 6.0	
6 mm ² AWG 10			
40A male crimp contacts		CXMA 1.5	
1,5 mm ² AWG 16		CXMA 2.5	
2,5 mm ² AWG 14		CXMA 4.0	
4 mm ² AWG 12		CXMA 6.0	
6 mm ² AWG 10			
10A female crimp contacts			
0,14-0,37 mm ² AWG 26-22 identification No. 1		CDFA 0.3	CDFD 0.3
0,5 mm ² AWG 20 identification No. 2		CDFA 0.5	CDFD 0.5
0,75 mm ² AWG 18 identification No. ②		CDFA 0.7	CDFD 0.7
1 mm ² AWG 18 identification No. 3		CDFA 1.0	CDFD 1.0
1,5 mm ² AWG 16 identification No. 4		CDFA 1.5	CDFD 1.5
2,5 mm ² AWG 14 identification No. 5		CDFA 2.5	CDFD 2.5
10A male crimp contacts			
0,14-0,37 mm ² AWG 26-22 identification No. 1		CDMA 0.3	CDMD 0.3
0,5 mm ² AWG 20 identification No. 2		CDMA 0.5	CDMD 0.5
0,75 mm ² AWG 18 identification No. ②		CDMA 0.7	CDMD 0.7
1 mm ² AWG 18 identification No. 3		CDMA 1.0	CDMD 1.0
1,5 mm ² AWG 16 identification No. 4		CDMA 1.5	CDMD 1.5
2,5 mm ² AWG 14 identification No. 5		CDMA 2.5	CDMD 2.5

silver plated

+ for basic or high thickness gold plating, please refer to page 674

gold plated+

MIXO INSERTS

- characteristics according to EN 61984:
- 3 poles 40A 830V 8kV 3**
- 4 poles 10A 830V 8kV 3**
- cULus (UL for USA and Canada),
- certified
- rated voltage according to UL/CSA: 600V
- insulation resistance: ≥ 10 GΩ
- ambient temperature limit: -40 °C ... +125 °C
- made of self-extinguishing thermoplastic resin UL 94V-0
- mechanical life: ≥ 500 cycles
- contact resistance: ≤ 0,3 mΩ (3 poles), ≤ 3 mΩ (4 poles)
- for max. current load see the connector inserts derating diagram below; for more information see page 28

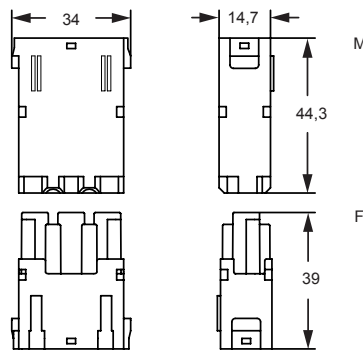

contacts side (front view)

side with reference arrow ▲

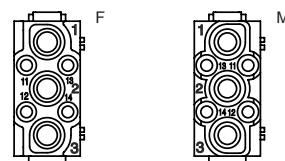

- 1 frame slot

- it is recommended to crimp the contacts with crimping tools homologated by ILME (please see the crimping tool section 40A contacts, CXF, CXM series and 10A contacts CDF, CDM series) on pages 708 - 741

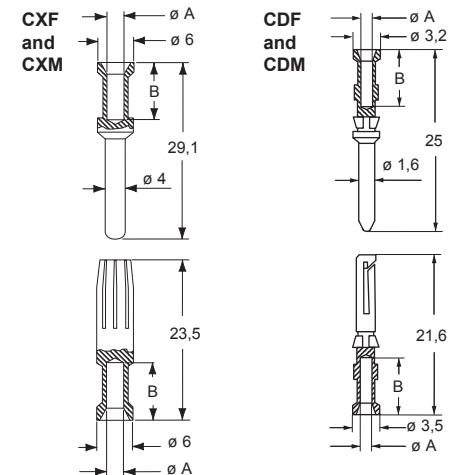

CXF and CXM contacts

conductor section (mm ²)	conductor slot ø A (mm)	conductor stripping length B (mm)
1,5	1,8	9
2,5	2,2	9
4	2,85	9,6
6	3,5	9,6

CDF and CDM contacts

conductor section (mm ²)	conductor slot ø A (mm)	conductor stripping length B (mm)
0,14-0,37	0,9	8
0,5	1,1	8
0,75	1,3	8
1,0	1,45	8
1,5	1,8	8
2,5	2,2	6

CX 3/4 XD, 3/4 poles connector inserts Maximum current load derating diagram

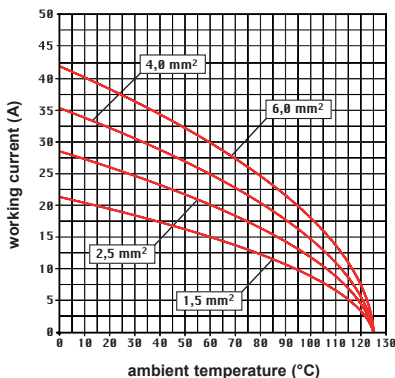

CX 04 XF/XM 4 poles 40A - 830V

The modular inserts must be installed in suitable frames which are then mounted in traditional enclosures* or in COB panel support.
Single-sized modular units may be directly mounted inside MIXO ONE enclosures.

frames for modular units* page: 316 - 317

MIXO ONE enclosures 369

* enclosures: bulkhead mounting housings, high construction housings or high construction hoods

modular units, crimp connections with red lock-in tab (included)



40A silver plated crimp contacts



description

part No.

part No

without contacts (to be ordered separately)
(module red lock-in tab included)
female inserts for female contacts
male inserts for male contacts

CX 04 XF
CX 04 XM

40A female crimp contacts
1,5 mm² AWG 16
2,5 mm² AWG 14
4 mm² AWG 12
6 mm² AWG 10

CXFA 1.5
CXFA 2.5
CXFA 4.0
CXFA 6.0

40A male crimp contacts
1,5 mm² AWG 16
2,5 mm² AWG 14
4 mm² AWG 12
6 mm² AWG 10

CXMA 1.5
CXMA 2.5
CXMA 4.0
CXMA 6.0

silver plated

- characteristics according to EN 61984:

40A 830V 8kV 3
40A 1000V 8kV 2

- cULus (UL for USA and Canada), SR, CQC, DNV-GL

- BUREAU VERITAS EAC certified

- rated voltage according to UL/CSA: 600V

- insulation resistance: $\geq 10 \text{ G}\Omega$

- ambient temperature limit: $-40 \text{ }^\circ\text{C} \dots +125 \text{ }^\circ\text{C}$

- made of self-extinguishing thermoplastic resin UL 94V-0

- mechanical life: ≥ 500 cycles

- contact resistance: $\leq 0,3 \text{ m}\Omega$

- for spare lock-in tab CX CFMX see SPARE SPARTS catalogue

- it is recommended to crimp the contacts with crimping tools homologated by ILME (please see the crimping tool section 40A contacts, CXF and CXM series) on pages 708 - 741

- for max. current load see the connector inserts derating diagram below; for more information see page 28

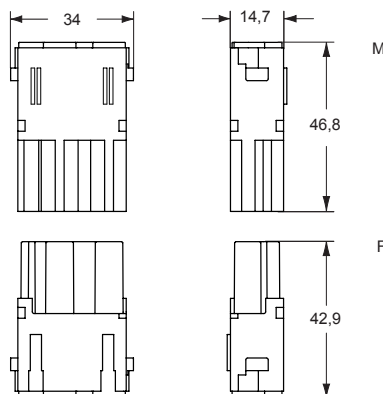

contacts side (front view)
side with reference arrow ▲

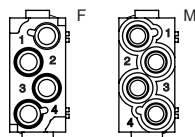

- 1 frame slot

Female inserts are supplied with two red lock tab that must be used instead of those supplied with the frames.

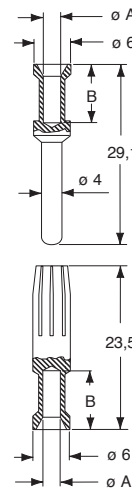
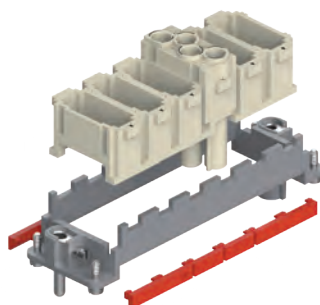

CXF and CXM contacts

conductor section (mm ²)	conductor slot σA (mm)	conductor stripping length B (mm)
1,5	1,8	9
2,5	2,2	9
4	2,85	9,6
6	3,5	9,6

- male and female contacts finger proof
- their key characteristic lies in the fact that they guarantee maximum safety even in case of accidental contact with fingers (IP2X or IPXXB). Safety is guaranteed as standard on female contacts, but also on male contacts. This feature is important as it ensures full compliance with the recent safety standard EN 60204-1, concerning electric equipment fitted on machines and in particular with the requirements of Article 6.2.4 concerning protection against residual voltage. In the case of plugs or similar devices, the withdrawal of which results in the exposure of conductors (for example pins), the discharge time shall not exceed 1 s, otherwise such conductors shall be protected against direct contact to at least an IP2X or IPXXB.

CX 04 X, 4 poles connector inserts
Maximum current load derating diagram

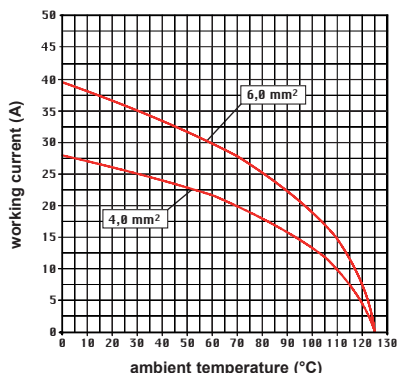

CX 05 SHF/SHM

MIXO - SQUICH®

SQUICH® technology has now been applied to the ILME MIXO series of modular connectors. Main aim is to make wiring an installation easier and safer on every possible connector.

On this purpose, the new MIXO SQUICH® 5 poles is the improved version of the CX 05 SF/SM spring clamp module:

- **consistently reduced wiring time**, as the actuator buttons are supplied lifted, in “open terminal” position, so that the stripped wires can be directly inserted;
- **operator skill independence**: thanks to the SQUICH® proprietary technology a simple pressure on the top of the actuator button triggers the locking of the conductor in the terminal, avoiding the need of a specific screwdriver and the relevant skill in its correct choice and application;
- **great resistance to strong vibrations** inherent to self-compensating spring-clamp technology;
- **no special wire preparation** (only stripping at the correct length);
- it allows the **use of both rigid and flexible** copper conductors, with a range of cross-sectional area between 0,14 mm² and 2,5 mm² (26 AWG to 14 AWG);
- for conductors prepared with **crimped ferrules**, the maximum cross-sectional area is 1,5 mm²;
- possibility to insert the **test probe** of a measurement instrument in the dedicated cavity on the actuator button (proprietary design);
- **silver plated** contacts;
- simple re-opening of a terminal (if needed) using a 0,5 x 3 mm flat blade screwdriver on the actuator button dedicated side window (on terminal #3 use the same screwdriver under any of the two lateral projections of the actuator button head; after removing the wire from the relevant terminal #1 or #4).

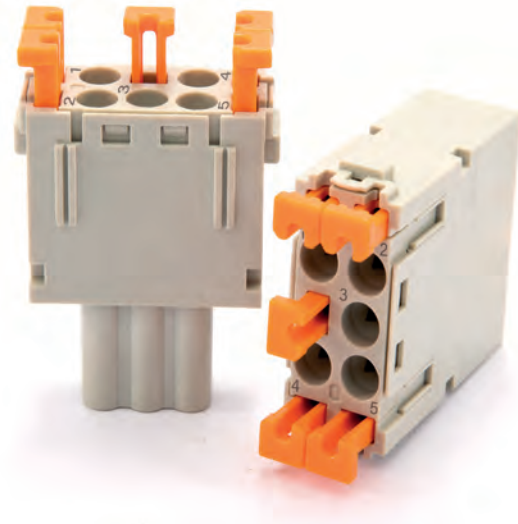

Watch
our
SQUICH®
video

The modular inserts must be installed in suitable frames which are then mounted in traditional enclosures or in COB panel support.
Single-sized modular units may be directly mounted inside MIXO ONE enclosures.

frames for modular units page:
316

MIXO ONE enclosures 369

Suitable for every conductor type (prepared with ferrule, unprepared and solid) up to cross-sectional area 2,5 mm²

modular units,
SQUICH®-spring terminal connection

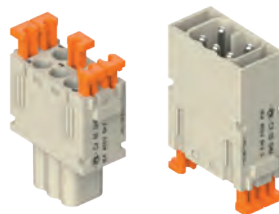

description

part No.

spring terminals with actuator button
female inserts with female contacts
male inserts with male contacts

CX 05 SHF
CX 05 SHM

- characteristics according to EN 61984:

16A 400V 6kV 3

16A 500V 6kV 2

- cURus, CSA, CQC, DNV-GL, BV, EAC pending

- rated voltage according to UL/CSA: 600V

- insulation resistance: ≥ 10 GΩ

- ambient temperature limit: -40 °C ... +125 °C

- made of self-extinguishing thermoplastic resin
UL 94V-0

- mechanical life: ≥ 500 cycles

- contact resistance: ≤ 3 mΩ

- for max. current load see the connector inserts derating diagram below; for more information see page 28

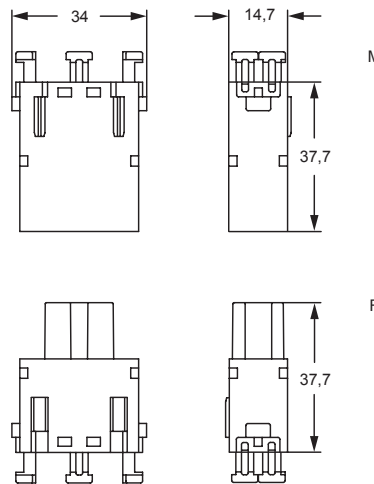

contacts side (front view)

rear view, side with reference arrow ▲

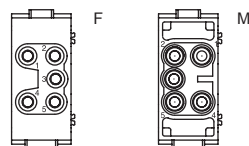

- 1 frame slot

- inserts for cables with the following cross-sectional area: 0,14 - 2,5 mm² - AWG 26 - 14
- conductors stripping length: 9...11 mm

CX 05 SH, 5 power poles connector inserts
Maximum current load derating diagram

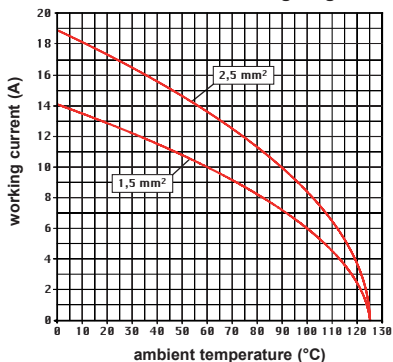

MIXO CX 05 SHF/M
SQUICH®-spring connection technology

WIRING

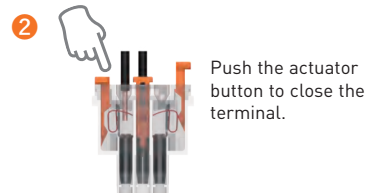
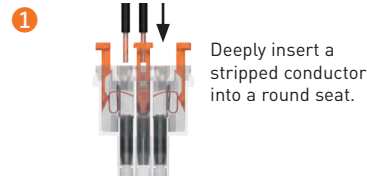

RE-OPENING

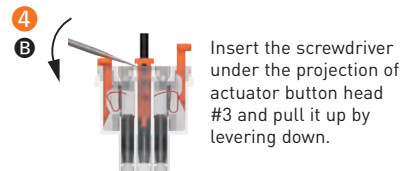
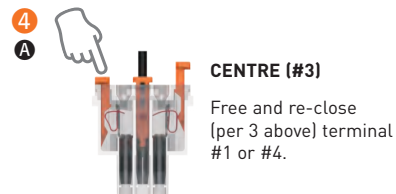
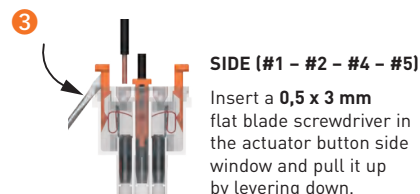

CX 06 CF/CM 6 poles 16A - 500V

The modular inserts must be installed in suitable frames which are then mounted in traditional enclosures or in COB panel support.
Single-sized modular units may be directly mounted inside MIXO ONE enclosures.

frames for modular units page: 316 - 317
MIXO ONE enclosures 369

- it is recommended to crimp the contacts with crimping tools homologated by ILME (please see the crimping tool section 16A contacts, CCF, CCM and CC...AN series) on pages 708 - 741

modular units, crimp connections

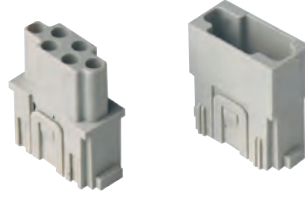

16A crimp contacts standard or for advanced opening silver and gold plated

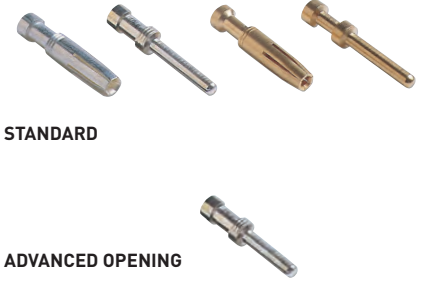

description	part No.	part No.	part No.
without contacts (to be ordered separately)			
female inserts for female contacts	CX 06 CF		
male inserts for male contacts	CX 06 CM		
16A female crimp contacts			
0,14-0,37 mm ² AWG 26-22 one groove		CCFA 0.3	CCFD 0.3
0,5 mm ² AWG 20 with no grooves		CCFA 0.5	CCFD 0.5
0,75 mm ² AWG 18 one groove (back side)		CCFA 0.7	CCFD 0.7
1 mm ² AWG 18 one groove		CCFA 1.0	CCFD 1.0
1,5 mm ² AWG 16 two grooves		CCFA 1.5	CCFD 1.5
2,5 mm ² AWG 14 three grooves		CCFA 2.5	CCFD 2.5
3 mm ² AWG 12 one wide groove		CCFA 3.0	CCFD 3.0
4 mm ² AWG 12 with no grooves		CCFA 4.0	CCFD 4.0
16A male crimp contacts			
0,14-0,37 mm ² AWG 26-22 one groove		CCMA 0.3	CCMD 0.3
0,5 mm ² AWG 20 with no grooves		CCMA 0.5	CCMD 0.5
0,75 mm ² AWG 18 one groove (back side)		CCMA 0.7	CCMD 0.7
1 mm ² AWG 18 one groove		CCMA 1.0	CCMD 1.0
1,5 mm ² AWG 16 two grooves		CCMA 1.5	CCMD 1.5
2,5 mm ² AWG 14 three grooves		CCMA 2.5	CCMD 2.5
3 mm ² AWG 12 one wide groove		CCMA 3.0	CCMD 3.0
4 mm ² AWG 12 with no grooves		CCMA 4.0	CCMD 4.0
16A male crimp contacts for advanced opening			
0,5 mm ² AWG 20 with no grooves		CC 0.5 AN	+ for basic or high thickness gold plating, please refer to page 675
0,75 mm ² AWG 18 one groove (back side)		CC 0.7 AN	
1 mm ² AWG 18 one groove		CC 1.0 AN	
1,5 mm ² AWG 16 two grooves		CC 1.5 AN	
2,5 mm ² AWG 14 three grooves		CC 2.5 AN	

- characteristics according to EN 61984:
- 16A 500V 6kV 3**
- 16A 400/690V 6kV 2**
- certified
- rated voltage according to UL/CSA: 600V
- insulation resistance: ≥ 10 GΩ
- ambient temperature limit: -40 °C ... +125 °C
- made of self-extinguishing thermoplastic resin UL 94V-0
- mechanical life: ≥ 500 cycles
- contact resistance: ≤ 1 mΩ
- for max. current load see the connector inserts derating diagram below; for more information see page 28

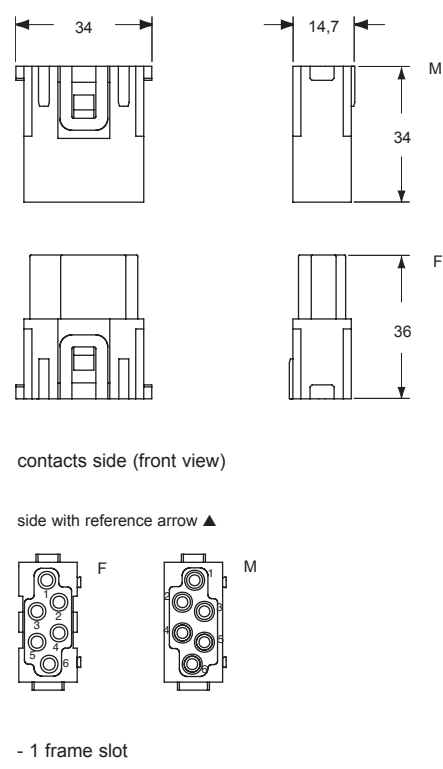
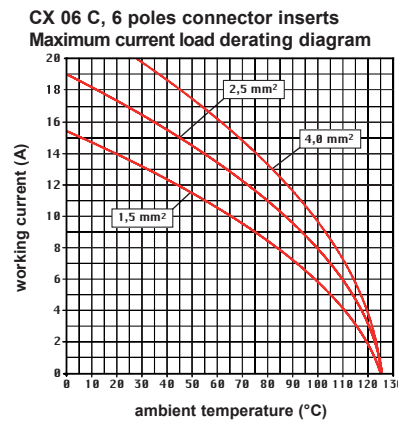

CCF and CCM		CC...AN	
CCF, CCM and CC...AN contacts			
conductor section (mm ²)	conductor slot ø A (mm)	conductor stripping length (mm)	
0,14-0,37	0,9	7,5	
0,5	1,1	7,5	
0,75	1,3	7,5	
1,0	1,45	7,5	
1,5	1,8	7,5	
2,5	2,2	7,5	
3	2,55	7,5	
4	2,85	7,5	

MIXO INSERTS

CX 06P CF/CM 6 poles protected 16A - 830V

The modular inserts must be installed in suitable frames which are then mounted in traditional enclosures or in COB panel support.

Single-sized modular units may be directly mounted inside MIXO ONE enclosures.

frames for modular units page:
316 - 317

MIXO ONE enclosures 369

- we recommend the use of CRF / CRM code pins together with relevant MIXO frame
- it is recommended to crimp the contacts with crimping tools homologated by ILME (please see the crimping tool section 16A contacts, CCF, CCM and CC...AN series) on pages 708 - 741

modular units, crimp connections



RATING 830V

16A crimp contacts standard or for advanced opening silver and gold plated

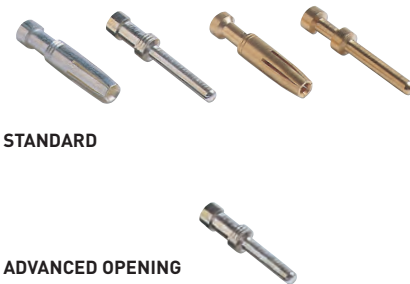

STANDARD

ADVANCED OPENING

description	part No.	part No.	part No.
without contacts (to be ordered separately)			
female inserts for female contacts	CX 06P CF		
male inserts for male contacts	CX 06P CM		
16A female contacts			
0,14-0,37 mm ² AWG 26-22 one groove		CCFA 0.3	CCFD 0.3
0,5 mm ² AWG 20 with no grooves		CCFA 0.5	CCFD 0.5
0,75 mm ² AWG 18 one groove (back side)		CCFA 0.7	CCFD 0.7
1 mm ² AWG 18 one groove		CCFA 1.0	CCFD 1.0
1,5 mm ² AWG 16 two grooves		CCFA 1.5	CCFD 1.5
2,5 mm ² AWG 14 three grooves		CCFA 2.5	CCFD 2.5
3 mm ² AWG 12 one wide groove		CCFA 3.0	CCFD 3.0
4 mm ² AWG 12 with no grooves		CCFA 4.0	CCFD 4.0
16A male contacts			
0,14-0,37 mm ² AWG 26-22 one groove		CCMA 0.3	CCMD 0.3
0,5 mm ² AWG 20 with no grooves		CCMA 0.5	CCMD 0.5
0,75 mm ² AWG 18 one groove (back side)		CCMA 0.7	CCMD 0.7
1 mm ² AWG 18 one groove		CCMA 1.0	CCMD 1.0
1,5 mm ² AWG 16 two grooves		CCMA 1.5	CCMD 1.5
2,5 mm ² AWG 14 three grooves		CCMA 2.5	CCMD 2.5
3 mm ² AWG 12 one wide groove		CCMA 3.0	CCMD 3.0
4 mm ² AWG 12 with no grooves		CCMA 4.0	CCMD 4.0
16A male crimp contacts for advanced opening			
0,5 mm ² AWG 20 with no grooves		CC 0.5 AN	+ for basic or high thickness gold plating, please refer to page 675
0,75 mm ² AWG 18 one groove (back side)		CC 0.7 AN	
1 mm ² AWG 18 one groove		CC 1.0 AN	
1,5 mm ² AWG 16 two grooves		CC 1.5 AN	
2,5 mm ² AWG 14 three grooves		CC 2.5 AN	

silver plated

gold plated+

MIXO INSERTS

- characteristics according to EN 61984:

16A 830V 8kV 3

- certified
- rated voltage according to UL/CSA: 600V
- insulation resistance: $\geq 10 \text{ G}\Omega$
- ambient temperature limit: $-40 \text{ }^\circ\text{C} \dots +125 \text{ }^\circ\text{C}$
- made of self-extinguishing thermoplastic resin UL 94V-0
- mechanical life: ≥ 500 cycles
- contact resistance: $\leq 1 \text{ m}\Omega$
- for max. current load see the connector inserts derating diagram below; for more information see page 28

CX 06P C, 6 poles connector inserts Maximum current load derating diagram

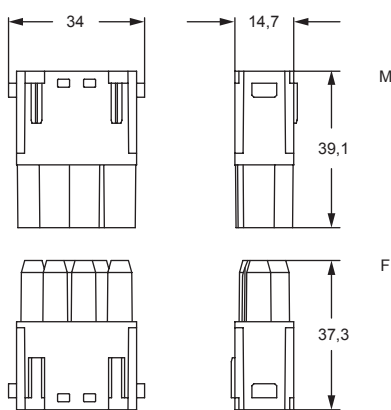
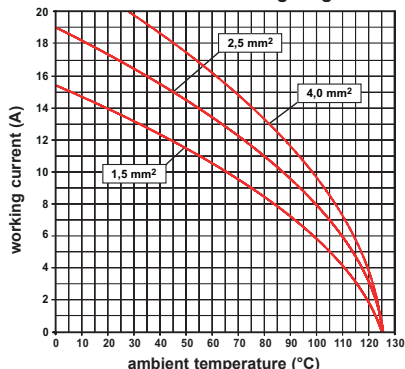

contacts side (front view)

side with reference arrow ▲

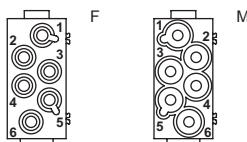

- 1 frame slot

CCF and CCM

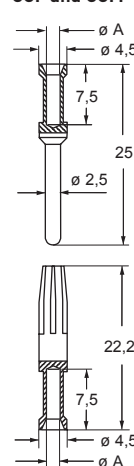

CC...AN

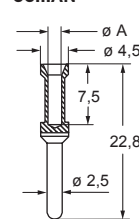

CCF, CCM and CC..AN contacts

conductor section (mm ²)	conductor slot Ø A (mm)	conductors stripping length (mm)
0,14-0,37	0,9	7,5
0,5	1,1	7,5
0,75	1,3	7,5
1,0	1,45	7,5
1,5	1,8	7,5
2,5	2,2	7,5
3	2,55	7,5
4	2,85	7,5

CX 08 CF/CM 8 poles 16A - 400V

The modular inserts must be installed in suitable frames which are then mounted in traditional enclosures or in COB panel support.
Single-sized modular units may be directly mounted inside MIXO ONE enclosures.

frames for modular units page: 316 - 317
MIXO ONE enclosures 369

modular units, crimp connections



16A crimp contacts standard or for advanced opening silver and gold plated

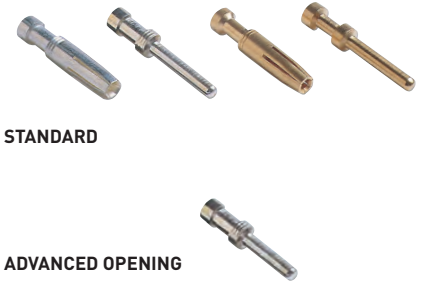

STANDARD

ADVANCED OPENING

description	part No.	part No.	part No.
without contacts (to be ordered separately)			
female inserts for female contacts	CX 08 CF		
male inserts for male contacts	CX 08 CM		
16A female crimp contacts			
0,14-0,37 mm ² AWG 26-22 one groove		CCFA 0.3	CCFD 0.3
0,5 mm ² AWG 20 with no grooves		CCFA 0.5	CCFD 0.5
0,75 mm ² AWG 18 one groove (back side)		CCFA 0.7	CCFD 0.7
1 mm ² AWG 18 one groove		CCFA 1.0	CCFD 1.0
1,5 mm ² AWG 16 two grooves		CCFA 1.5	CCFD 1.5
2,5 mm ² AWG 14 three grooves		CCFA 2.5	CCFD 2.5
3 mm ² AWG 12 one wide groove		CCFA 3.0	CCFD 3.0
4 mm ² AWG 12 with no grooves		CCFA 4.0	CCFD 4.0
16A male crimp contacts			
0,14-0,37 mm ² AWG 26-22 one groove		CCMA 0.3	CCMD 0.3
0,5 mm ² AWG 20 with no grooves		CCMA 0.5	CCMD 0.5
0,75 mm ² AWG 18 one groove (back side)		CCMA 0.7	CCMD 0.7
1 mm ² AWG 18 one groove		CCMA 1.0	CCMD 1.0
1,5 mm ² AWG 16 two grooves		CCMA 1.5	CCMD 1.5
2,5 mm ² AWG 14 three grooves		CCMA 2.5	CCMD 2.5
3 mm ² AWG 12 one wide groove		CCMA 3.0	CCMD 3.0
4 mm ² AWG 12 with no grooves		CCMA 4.0	CCMD 4.0
16A male crimp contacts for advanced opening			
0,5 mm ² AWG 20 with no grooves		CC 0.5 AN	+ for basic or high thickness gold plating, please refer to page 675
0,75 mm ² AWG 18 one groove (back side)		CC 0.7 AN	
1 mm ² AWG 18 one groove		CC 1.0 AN	
1,5 mm ² AWG 16 two grooves		CC 1.5 AN	
2,5 mm ² AWG 14 three grooves		CC 2.5 AN	

- characteristics according to EN 61984:
- 16A 400V 6kV 3**
- 16A 400/690V 6kV 2**
- certified
- rated voltage according to UL/CSA: 600V
- insulation resistance: ≥ 10 GΩ
- ambient temperature limit: -40 °C ... +125 °C
- made of self-extinguishing thermoplastic resin UL 94V-0
- mechanical life: ≥ 500 cycles
- contact resistance: ≤ 1 mΩ
- for max. current load see the connector inserts derating diagram below; for more information see page 28

CX 08 C, 8 poles connector inserts

Maximum current load derating diagram

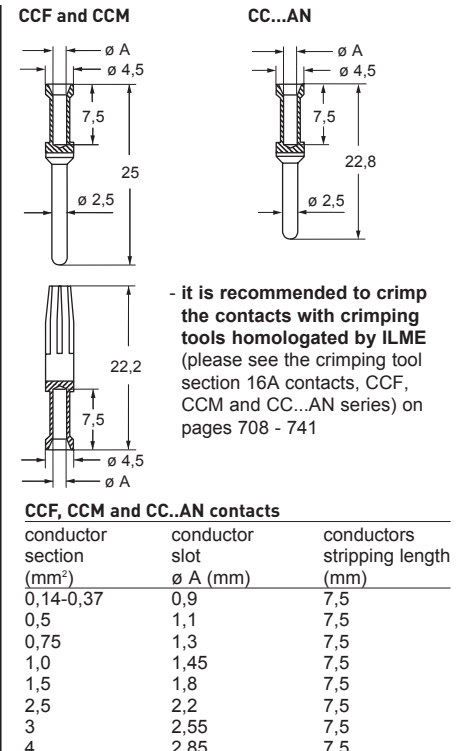
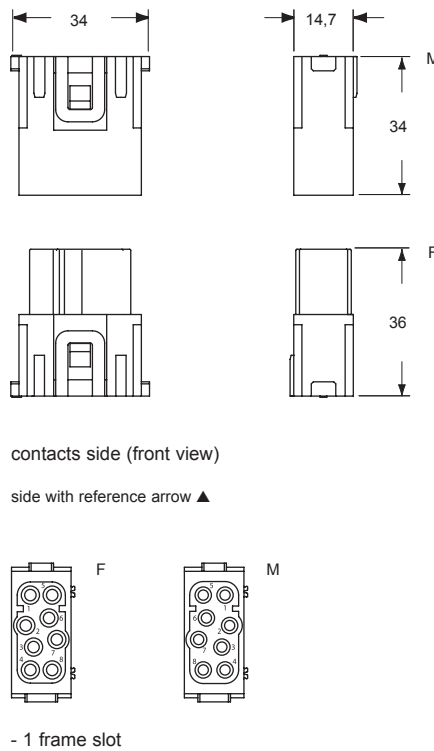
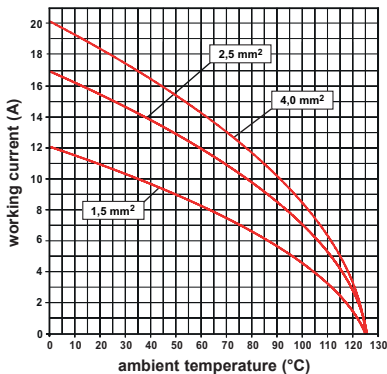

CX 20 CF/CM 20 poles 16A - 500V

The modular inserts must be installed in suitable frames, which are then mounted in traditional enclosures or in COB panel supports.

frames for modular units page:
316 - 317

- it is recommended to crimp the contacts with crimping tools homologated by ILME (please see the crimping tool section 16A contacts, CCF, CCM and CC...AN series) on pages 708 - 741

modular units, crimp connections



16A crimp contacts standard or for advanced opening silver and gold plated



STANDARD

ADVANCED OPENING

description	part No.	part No.	part No.
without contacts (to be ordered separately)			
female inserts for female contacts ¹⁾	CX 20 CF		
male inserts for male contacts ¹⁾	CX 20 CM		
16A female crimp contacts			
0,14-0,37 mm ² AWG 26-22 one groove	CCFA 0.3	CCFD 0.3	
0,5 mm ² AWG 20 with no grooves	CCFA 0.5	CCFD 0.5	
0,75 mm ² AWG 18 one groove (back side)	CCFA 0.7	CCFD 0.7	
1 mm ² AWG 18 one groove	CCFA 1.0	CCFD 1.0	
1,5 mm ² AWG 16 two grooves	CCFA 1.5	CCFD 1.5	
2,5 mm ² AWG 14 three grooves	CCFA 2.5	CCFD 2.5	
3 mm ² AWG 12 one wide groove	CCFA 3.0	CCFD 3.0	
4 mm ² AWG 12 with no grooves	CCFA 4.0	CCFD 4.0	
16A male crimp contacts			
0,14-0,37 mm ² AWG 26-22 one groove	CCMA 0.3	CCMD 0.3	
0,5 mm ² AWG 20 with no grooves	CCMA 0.5	CCMD 0.5	
0,75 mm ² AWG 18 one groove (back side)	CCMA 0.7	CCMD 0.7	
1 mm ² AWG 18 one groove	CCMA 1.0	CCMD 1.0	
1,5 mm ² AWG 16 two grooves	CCMA 1.5	CCMD 1.5	
2,5 mm ² AWG 14 three grooves	CCMA 2.5	CCMD 2.5	
3 mm ² AWG 12 one wide groove	CCMA 3.0	CCMD 3.0	
4 mm ² AWG 12 with no grooves	CCMA 4.0	CCMD 4.0	
16A male crimp contacts for advanced opening			
0,5 mm ² AWG 20 with no grooves	CC 0.5 AN		+ for basic or high thickness gold plating, please refer to page 675
0,75 mm ² AWG 18 one groove (back side)	CC 0.7 AN		
1 mm ² AWG 18 one groove	CC 1.0 AN		
1,5 mm ² AWG 16 two grooves	CC 1.5 AN		
2,5 mm ² AWG 14 three grooves	CC 2.5 AN		

¹⁾ on request, version with 3 fastened CX 20 CF/CM inserts with poles numbered from 1 – 60 references: **CX 60 CF, CX 60 CM**

- characteristics according to EN 61984:

16A 500V 6kV 3
16A 830V 8kV 2

- (UL for USA and Canada),

- certified

- rated voltage according to UL/CSA: 600V

- insulation resistance: $\geq 10 \text{ G}\Omega$

- ambient temperature limit: -40 °C ... +125 °C

- made of self-extinguishing thermoplastic resin UL 94V-0

- mechanical life: ≥ 500 cycles

- contact resistance: $\leq 1 \text{ m}\Omega$

- for max. current load see the connector inserts derating diagram below; for more information see page 28

CX 20 C, 20 poles connector inserts
Maximum current load derating diagram

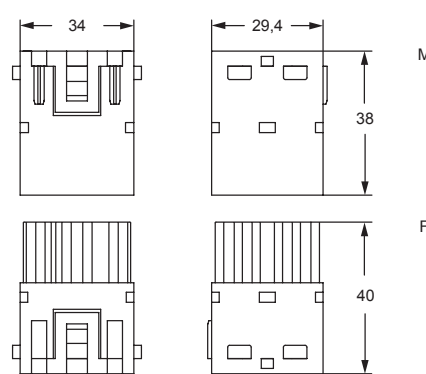
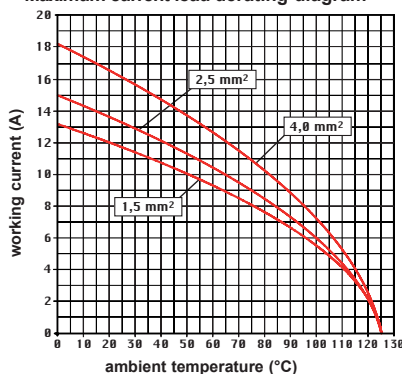

contacts side (front view)

side with reference arrow ▲

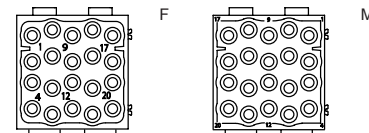

- 2 frame slots

CCF and CCM

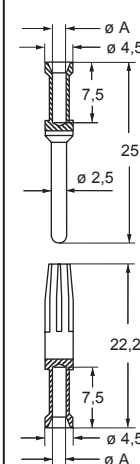

CC...AN

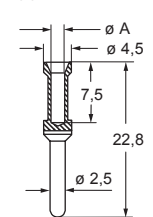

CCF, CCM and CC...AN contacts

conductor section (mm ²)	conductor slot $\varnothing A$ (mm)	conductors stripping length (mm)
0,14-0,37	0,9	7,5
0,5	1,1	7,5
0,75	1,3	7,5
1,0	1,45	7,5
1,5	1,8	7,5
2,5	2,2	7,5
3	2,55	7,5
4	2,85	7,5

MIXO INSERTS

HT 2 poles single module 16A - 2500V

The modular inserts must be installed in suitable frames which are then mounted in traditional enclosures* or in COB panel support.
Single-sized modular units may be directly mounted inside MIXO ONE enclosures.

frames for modular units* page: 316 - 317
MIXO ONE enclosures 369

* enclosures: bulkhead mounting housings, high construction housings or high construction hoods

1) supplied with heat shrink insulating tubes for the rear of the contacts

high voltage modular units, crimp connections

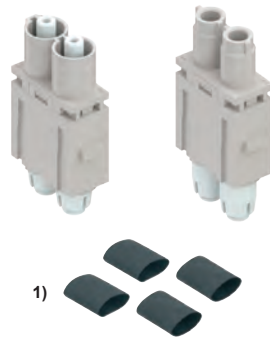

16A crimp contacts silver and gold plated



description	part No.	part No.	part No.
without contacts (to be ordered separately)			
high voltage female inserts for female contacts	CX 02 CHF		
high voltage male inserts for male contacts	CX 02 CHM		
contact holder removal tool	CH1ES		
16A female crimp contacts			
0,5 mm ² AWG 20 with no grooves		CCFA 0.5	CCFD 0.5
0,75 mm ² AWG 18 one groove (back side)		CCFA 0.7	CCFD 0.7
1 mm ² AWG 18 one groove		CCFA 1.0	CCFD 1.0
1,5 mm ² AWG 16 two grooves		CCFA 1.5	CCFD 1.5
2,5 mm ² AWG 14 three grooves		CCFA 2.5	CCFD 2.5
3 mm ² AWG 12 one wide groove		CCFA 3.0	CCFD 3.0
4 mm ² AWG 12 with no grooves		CCFA 4.0	CCFD 4.0
16A male crimp contacts			
0,5 mm ² AWG 20 with no grooves		CCMA 0.5	CCMD 0.5
0,75 mm ² AWG 18 one groove (back side)		CCMA 0.7	CCMD 0.7
1 mm ² AWG 18 one groove		CCMA 1.0	CCMD 1.0
1,5 mm ² AWG 16 two grooves		CCMA 1.5	CCMD 1.5
2,5 mm ² AWG 14 three grooves		CCMA 2.5	CCMD 2.5
3 mm ² AWG 12 one wide groove		CCMA 3.0	CCMD 3.0
4 mm ² AWG 12 with no grooves		CCMA 4.0	CCMD 4.0

- characteristics according to EN 61984 2): **16A 2500V 15kV 3**
- 2) used for guidance as applicable
- cURus, CSA, CQC, DNV-GL, BV, EAC pending
- insulation resistance: $\geq 10 \text{ G}\Omega$
- ambient temperature limit: $-40 \text{ }^\circ\text{C} \dots +125 \text{ }^\circ\text{C}$
- made of self-extinguishing thermoplastic resin UL 94V-0
- mechanical life: ≥ 500 cycles
- contact resistance: $\leq 1 \text{ m}\Omega$
- **it is recommended to crimp the contacts with crimping tools homologated by ILME** (please see the crimping tool section 16A contacts, CCF and CCM series) on pages 708 - 741
- contact holder removal tool: **CH1ES**



CH1ES

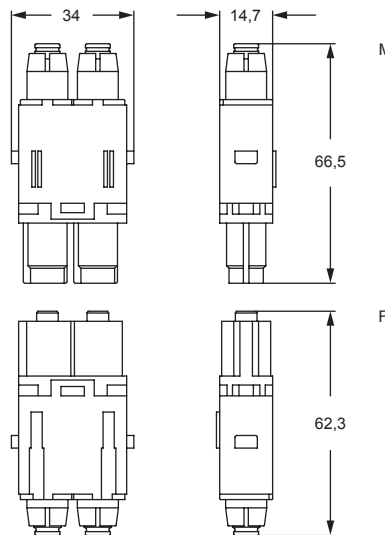

contacts side (front view)

side with reference arrow ▲

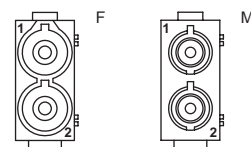

- 1 frame slot

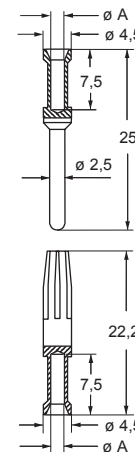

CCF and CCM contacts

conductor section (mm ²)	conductor slot $\varnothing A$ (mm)	conductors stripping length (mm)
0,5	1,1	9,5
0,75	1,3	9,5
1,0	1,45	9,5
1,5	1,8	9,5
2,5	2,2	9,5
3	2,55	9,5
4	2,85	9,5

+ for basic or high thickness gold plating, please refer to page 675



Watch our online tutorial

HT 2 poles 16A - 2900/5000V

The modular inserts must be installed in suitable frames, which are then mounted in traditional enclosures* or in COB panel supports.

frames for modular units*

page: 316

* enclosures: bulkhead mounting housings, high construction housings or high construction hoods

1) supplied with heat shrink insulating tubes for the rear of the contacts

high voltage modular units, crimp connections contact holder removal tool

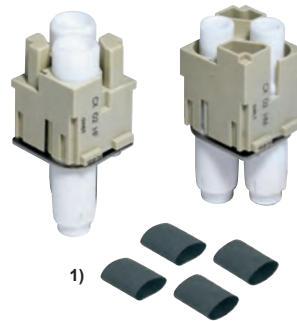

16A crimp contacts silver and gold plated



description	part No.	part No.	part No.
without contacts (to be ordered separately)			
high voltage female inserts for female contacts	CX 02 HF		
high voltage male inserts for male contacts	CX 02 HM		
contact holder removal tool	CHES		
16A female crimp contacts			
0,5 mm ² AWG 20 with no grooves		CCFA 0.5	CCFD 0.5
0,75 mm ² AWG 18 one groove (back side)		CCFA 0.7	CCFD 0.7
1 mm ² AWG 18 one groove		CCFA 1.0	CCFD 1.0
1,5 mm ² AWG 16 two grooves		CCFA 1.5	CCFD 1.5
2,5 mm ² AWG 14 three grooves		CCFA 2.5	CCFD 2.5
3 mm ² AWG 12 one wide groove		CCFA 3.0	CCFD 3.0
4 mm ² AWG 12 with no grooves		CCFA 4.0	CCFD 4.0
16A male crimp contacts			
0,5 mm ² AWG 20 with no grooves		CCMA 0.5	CCMD 0.5
0,75 mm ² AWG 18 one groove (back side)		CCMA 0.7	CCMD 0.7
1 mm ² AWG 18 one groove		CCMA 1.0	CCMD 1.0
1,5 mm ² AWG 16 two grooves		CCMA 1.5	CCMD 1.5
2,5 mm ² AWG 14 three grooves		CCMA 2.5	CCMD 2.5
3 mm ² AWG 12 one wide groove		CCMA 3.0	CCMD 3.0
4 mm ² AWG 12 with no grooves		CCMA 4.0	CCMD 4.0

MIXO INSERTS

silver plated

gold plated+

- characteristics according to EN 61984 2):
- 16A 2900/5000V 15kV 3**
- 2) used for guidance as applicable
- cURus, CSA, CQC, DNV-GL, BV, EAC pending
- insulation resistance: $\geq 10 \text{ G}\Omega$
- ambient temperature limit: $-40 \text{ }^\circ\text{C} \dots +125 \text{ }^\circ\text{C}$
- made of self-extinguishing thermoplastic resin UL 94V-0
- mechanical life: ≥ 500 cycles
- contact resistance: $\leq 1 \text{ m}\Omega$
- **it is recommended to crimp the contacts with crimping tools homologated by ILME** (please see the crimping tool section 16A contacts, CCF and CCM series) on pages 708 - 741
- contact holder removal tool: **CHES**
- maximum diameter of the cable insulation: 8 mm



CHES

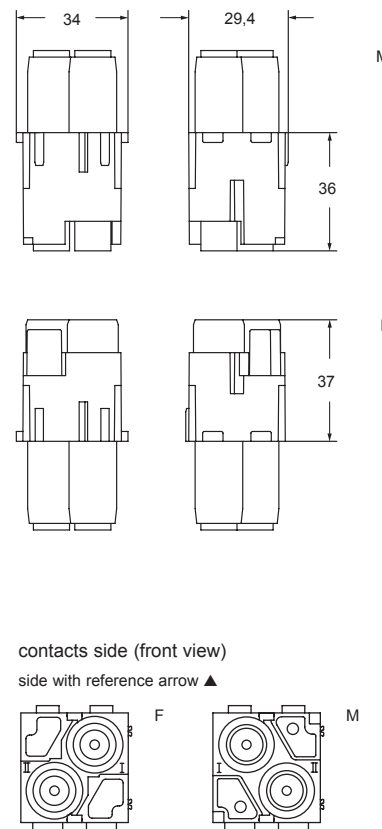

- 2 frame slots

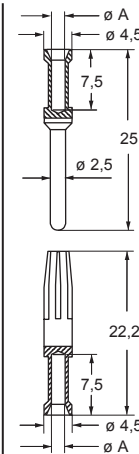

CCF and CCM contacts

conductor section (mm ²)	conductor slot $\varnothing A$ (mm)	conductors stripping length (mm)
0,14-0,37	0,9	9,5
0,5	1,1	9,5
0,75	1,3	9,5
1,0	1,45	9,5
1,5	1,8	9,5
2,5	2,2	9,5
3	2,55	9,5
4	2,85	9,5

+ for basic or high thickness gold plating, please refer to page 675

CX 12 DF/DM 12 poles 10A - 250V

The modular inserts must be installed in suitable frames which are then mounted in traditional enclosures* or in COB panel support.
Single-sized modular units may be directly mounted inside MIXO ONE enclosures.

frames for modular units*	page: 316 - 317
MIXO ONE enclosures	369

* enclosures: bulkhead mounting housings, high construction housings or high construction hoods

modular units,
crimp connections

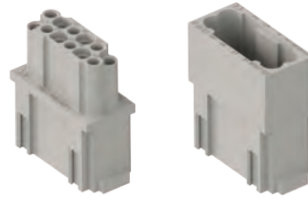

RATING 250V

10A crimp contacts,
silver and gold plated



description	part No.	part No.	part No.
without contacts (to be ordered separately)			
female inserts for female contacts	CX 12 DF		
male inserts for male contacts	CX 12 DM		
10A female crimp contacts			
0,14-0,37 mm ² AWG 26-22 identification No. 1		CDFA 0.3	CDFD 0.3
0,5 mm ² AWG 20 identification No. 2		CDFA 0.5	CDFD 0.5
0,75 mm ² AWG 18 identification No. ②		CDFA 0.7	CDFD 0.7
1 mm ² AWG 18 identification No. 3		CDFA 1.0	CDFD 1.0
1,5 mm ² AWG 16 identification No. 4		CDFA 1.5	CDFD 1.5
2,5 mm ² AWG 14 identification No. 5		CDFA 2.5	CDFD 2.5
10A male crimp contacts			
0,14-0,37 mm ² AWG 26-22 identification No. 1		CDMA 0.3	CDMD 0.3
0,5 mm ² AWG 20 identification No. 2		CDMA 0.5	CDMD 0.5
0,75 mm ² AWG 18 identification No. ②		CDMA 0.7	CDMD 0.7
1 mm ² AWG 18 identification No. 3		CDMA 1.0	CDMD 1.0
1,5 mm ² AWG 16 identification No. 4		CDMA 1.5	CDMD 1.5
2,5 mm ² AWG 14 identification No. 5		CDMA 2.5	CDMD 2.5

silver plated

gold plated+

- characteristics according to EN 61984:
- 10A 250V 4kV 3**
- certified
- rated voltage according to UL/CSA: 600V
- insulation resistance: ≥ 10 GΩ
- ambient temperature limit: -40 °C ... +125 °C
- made of self-extinguishing thermoplastic resin UL 94V-0
- mechanical life: ≥ 500 cycles
- contact resistance: ≤ 3 mΩ
- PCBs interface, refer to article CIF 2.4 on page 670
- **it is recommended to crimp the contacts with crimping tools homologated by ILME** (please see the crimping tool section 10A contacts, CDF and CDM series) on pages 708 - 741
- for max. current load see the connector inserts derating diagram below; for more information see page 28

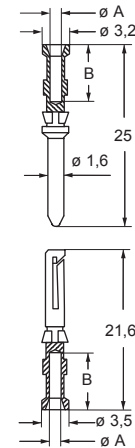
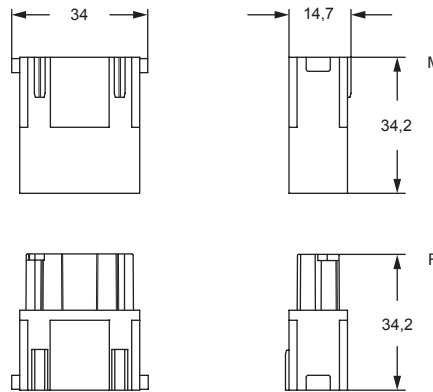

contacts side (front view)

side with reference arrow ▲

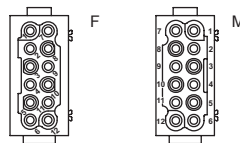

- 1 frame slot

CX 12 D, 12 poles connector inserts
Maximum current load derating diagram

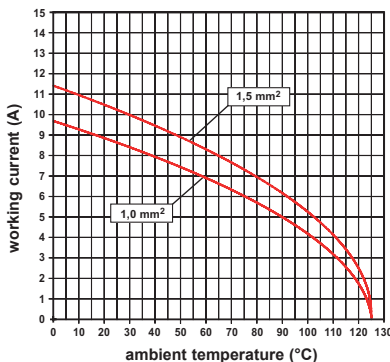

CDF and CDM contacts

conductor section (mm ²)	conductor slot $\varnothing A$ (mm)	conductors stripping length B (mm)
0,14-0,37	0,9	8
0,5	1,1	8
0,75	1,3	8
1,0	1,45	8
1,5	1,8	8
2,5	2,2	6

+ for basic or high thickness gold plating, please refer to page 674

CX 17 DF/DM 17 poles 10A - 160V

The modular inserts must be installed in suitable frames which are then mounted in traditional enclosures or in COB panel support.
Single-sized modular units may be directly mounted inside MIXO ONE enclosures.

frames for modular units page: 316 - 317
MIXO ONE enclosures 369

modular units,
crimp connections

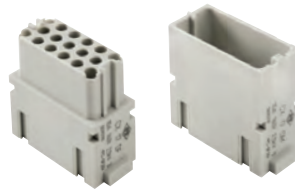

10A crimp contacts,
silver and gold plated



description	part No.	part No.	part No.
without contacts (to be ordered separately)			
female inserts for female contacts	CX 17 DF		
male inserts for male contacts	CX 17 DM		
10A female crimp contacts			
0,14-0,37 mm ² AWG 26-22 identification No. 1		CDFA 0.3	CDFD 0.3
0,5 mm ² AWG 20 identification No. 2		CDFA 0.5	CDFD 0.5
0,75 mm ² AWG 18 identification No. ②		CDFA 0.7	CDFD 0.7
1 mm ² AWG 18 identification No. 3		CDFA 1.0	CDFD 1.0
1,5 mm ² AWG 16 identification No. 4		CDFA 1.5	CDFD 1.5
2,5 mm ² AWG 14 identification No. 5		CDFA 2.5	CDFD 2.5
10A male crimp contacts			
0,14-0,37 mm ² AWG 26-22 identification No. 1		CDMA 0.3	CDMD 0.3
0,5 mm ² AWG 20 identification No. 2		CDMA 0.5	CDMD 0.5
0,75 mm ² AWG 18 identification No. ②		CDMA 0.7	CDMD 0.7
1 mm ² AWG 18 identification No. 3		CDMA 1.0	CDMD 1.0
1,5 mm ² AWG 16 identification No. 4		CDMA 1.5	CDMD 1.5
2,5 mm ² AWG 14 identification No. 5		CDMA 2.5	CDMD 2.5

silver plated

gold plated+

MIXO INSERTS

- characteristics according to EN 61984:

10A 160V 2,5kV 3
10A 250V 4kV 2

- us (UL for USA and Canada), cec DNV-GL

- certified

- rated voltage according to UL/CSA: 250V

- insulation resistance: ≥ 10 GΩ

- ambient temperature limit: -40 °C ... +125 °C

- made of self-extinguishing thermoplastic resin
UL 94V-0

- mechanical life: ≥ 500 cycles

- contact resistance: ≤ 3 mΩ

- **it is recommended to crimp the contacts with crimping tools homologated by ILME** (please see the crimping tool section 10A contacts, CDF and CDM series) on pages 708 - 741

- for max. current load see the connector inserts derating diagram below; for more information see page 28

CX 17 D, 17 poles connector inserts
Maximum current load derating diagram

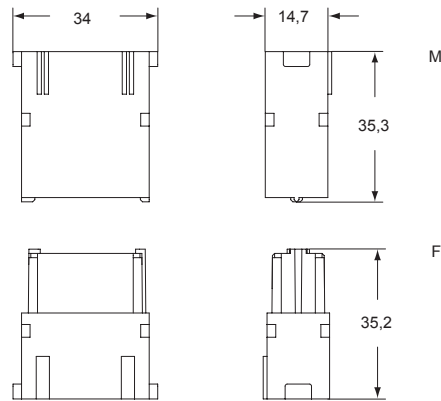
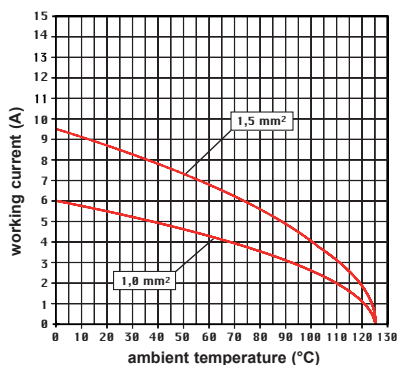

contacts side (front view)

side with reference arrow ▲

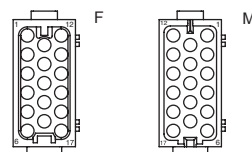

- 1 frame slot

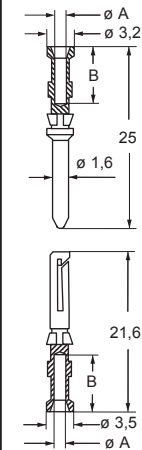

CDF and CDM contacts

conductor section (mm ²)	conductor slot Ø A (mm)	conductors stripping length B (mm)
0,14-0,37	0,9	8
0,5	1,1	8
0,75	1,3	8
1,0	1,45	8
1,5	1,8	8
2,5	2,2	6

+ for basic or high thickness gold plating, please refer to page 674

CX 42 DF/DM 42 poles 10A - 150V

The modular inserts must be installed in suitable frames, which are then mounted in traditional enclosures* or in COB panel supports.

frames for modular units*

page: 316

* enclosures: bulkhead mounting housings, high construction housings or high construction hoods

modular units, crimp connections

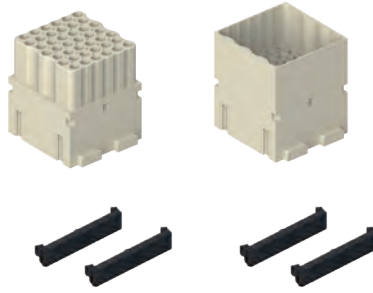

10A crimp contacts, silver and gold plated



description	part No.	part No.	part No.
-------------	----------	----------	----------

without contacts (to be ordered separately), supplied with 2 dedicated black coloured 2-slot sized lock-in tab female inserts for female contacts
male inserts for male contacts

CX 42 DF
CX 42 DM

10A female crimp contacts

0,14-0,37 mm ²	AWG 26-22	identification No. 1
0,5 mm ²	AWG 20	identification No. 2
0,75 mm ²	AWG 18	identification No. ②
1 mm ²	AWG 18	identification No. 3
1,5 mm ²	AWG 16	identification No. 4
2,5 mm ²	AWG 14	identification No. 5

10A male crimp contacts

0,14-0,37 mm ²	AWG 26-22	identification No. 1
0,5 mm ²	AWG 20	identification No. 2
0,75 mm ²	AWG 18	identification No. ②
1 mm ²	AWG 18	identification No. 3
1,5 mm ²	AWG 16	identification No. 4
2,5 mm ²	AWG 14	identification No. 5

CDFA 0.3
CDFA 0.5
CDFA 0.7
CDFA 1.0
CDFA 1.5
CDFA 2.5

silver plated

CDFD 0.3
CDFD 0.5
CDFD 0.7
CDFD 1.0
CDFD 1.5
CDFD 2.5

gold plated⁺

CDMA 0.3
CDMA 0.5
CDMA 0.7
CDMA 1.0
CDMA 1.5
CDMA 2.5

CDMD 0.3
CDMD 0.5
CDMD 0.7
CDMD 1.0
CDMD 1.5
CDMD 2.5

- characteristics according to EN 61984:

10A 150V 2,5kV 3

- cULus (UL for USA and Canada) certified, CSA, CQC, DNV-GL, BV, EAC pending
- rated voltage according to UL/CSA: 250V
- insulation resistance: ≥ 10 GΩ
- ambient temperature limit: -40 °C ... +125 °C
- made of self-extinguishing thermoplastic resin UL 94V-0
- mechanical life: ≥ 500 cycles
- contact resistance: ≤ 3 mΩ
- supplied with dedicated black coloured 2-slot sized lock-in tab (2, one per each side).
- for spare lock-in tab **CX CFMD** see SPARE SPARTS catalogue
- **it is recommended to crimp the contacts with crimping tools homologated by ILME** (please see the crimping tool section 10A contacts, CDF and CDM series) on pages 708 - 741
- for max. current load see the connector inserts derating diagram below; for more information see page 28

CX 42 D, 42 poles connector inserts
Maximum current load derating diagram

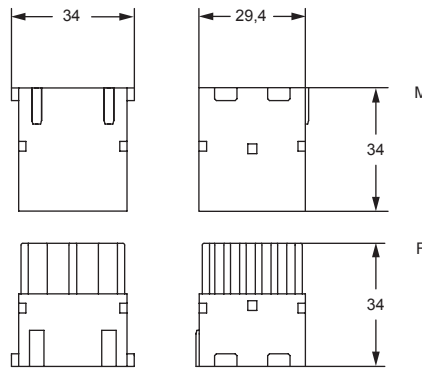
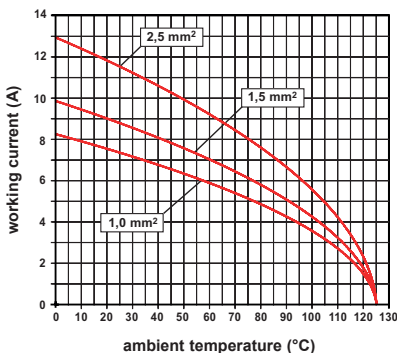

contacts side (front view)

rear view, side with reference arrow ▲

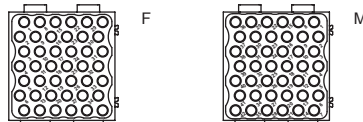

- 2 frame slots

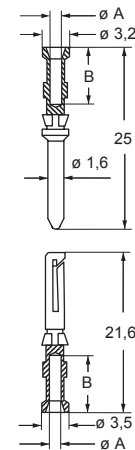

CDF and CDM contacts

conductor section (mm ²)	conductor slot ø A (mm)	conductors stripping length B (mm)
0,14-0,37	0,9	8
0,5	1,1	8
0,75	1,3	8
1,0	1,45	8
1,5	1,8	8
2,5	2,2	6

⁺ for basic or high thickness gold plating, please refer to page 674

CX 25 IBF/IBM 25 poles 4A - 50V

The modular inserts must be installed in suitable frames which are then mounted in traditional enclosures or in COB panel support.
Single-sized modular units may be directly mounted inside MIXO ONE enclosures.

frames for modular units page: 316 - 317
MIXO ONE enclosures 369

- max insulating diameter 2,1 mm
- we recommend the use of CRF / CRM code pins

modular units,
crimp connections

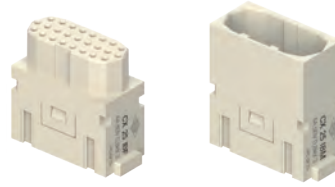

CI (4A) crimp contacts,
silver and gold plated



description	part No.	part No.	part No.
without contacts (to be ordered separately)			
female inserts for female contacts	CX 25 IBF		
male inserts for male contacts	CX 25 IBM		
CI (4A) female crimp contacts			
0,08-0,21 mm ² AWG 28-24		CIFA 0.2	CIFD 0.2
0,13-0,33 mm ² AWG 26-22		CIFA 0.3	CIFD 0.3
0,33-0,52 mm ² AWG 22-20		CIFA 0.5	CIFD 0.5
0,52-0,75 mm ² AWG 20-18		CIFA 0.7	CIFD 0.7
CI (4A) male crimp contacts			
0,08-0,21 mm ² AWG 28-24		CIMA 0.2	CIMD 0.2
0,13-0,33 mm ² AWG 26-22		CIMA 0.3	CIMD 0.3
0,33-0,52 mm ² AWG 22-20		CIMA 0.5	CIMD 0.5
0,52-0,75 mm ² AWG 20-18		CIMA 0.7	CIMD 0.7

MIXO INSERTS

- characteristics according to EN 61984:
- 4A 50V 0,8kV 3**
- 4A 160V 2,5kV 2**
- certified
- rated voltage according to UL/CSA: 600V
- insulation resistance: ≥ 10 GΩ
- ambient temperature limit: -40 °C ... +125 °C
- made of self-extinguishing thermoplastic resin UL 94V-0
- mechanical life: ≥ 500 cycles
- contact resistance: ≤ 4 mΩ
- for crimp contacts CI series use, on page 716 - 719
- CIPZ D** crimping tool
- CITP D** turret head
- CIES** insertion / removal tool for contacts 0,2 - 0,5 mm²
- CIES B** insertion / removal tool for contacts 0,75 mm²
- for max. current load see the connector inserts derating diagram below; for more information see page 28

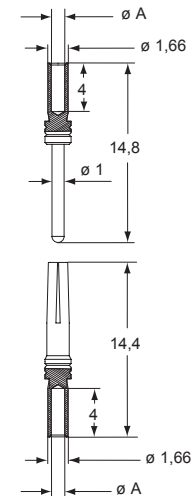
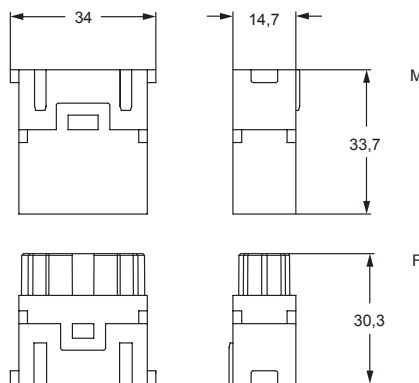

contacts side (front view)

side with reference arrow ▲

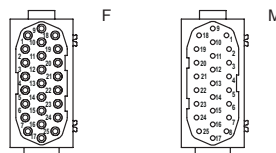

- 1 frame slot

CIF and CIM contacts

conductor section (mm ²)	conductor slot ϕA (mm)	conductors stripping length (mm)
0,08-0,21	0,64	4
0,13-0,33	0,90	4
0,33-0,52	1,12	4
0,52-0,75	1,12	4

CX 25 IB, 25 poles connector inserts
Maximum current load derating diagram

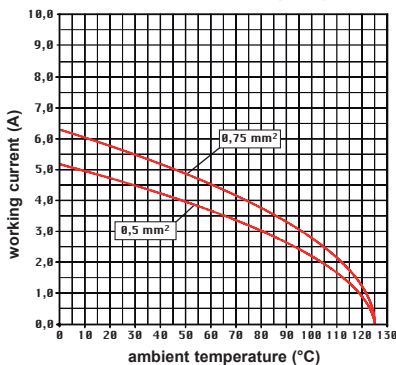

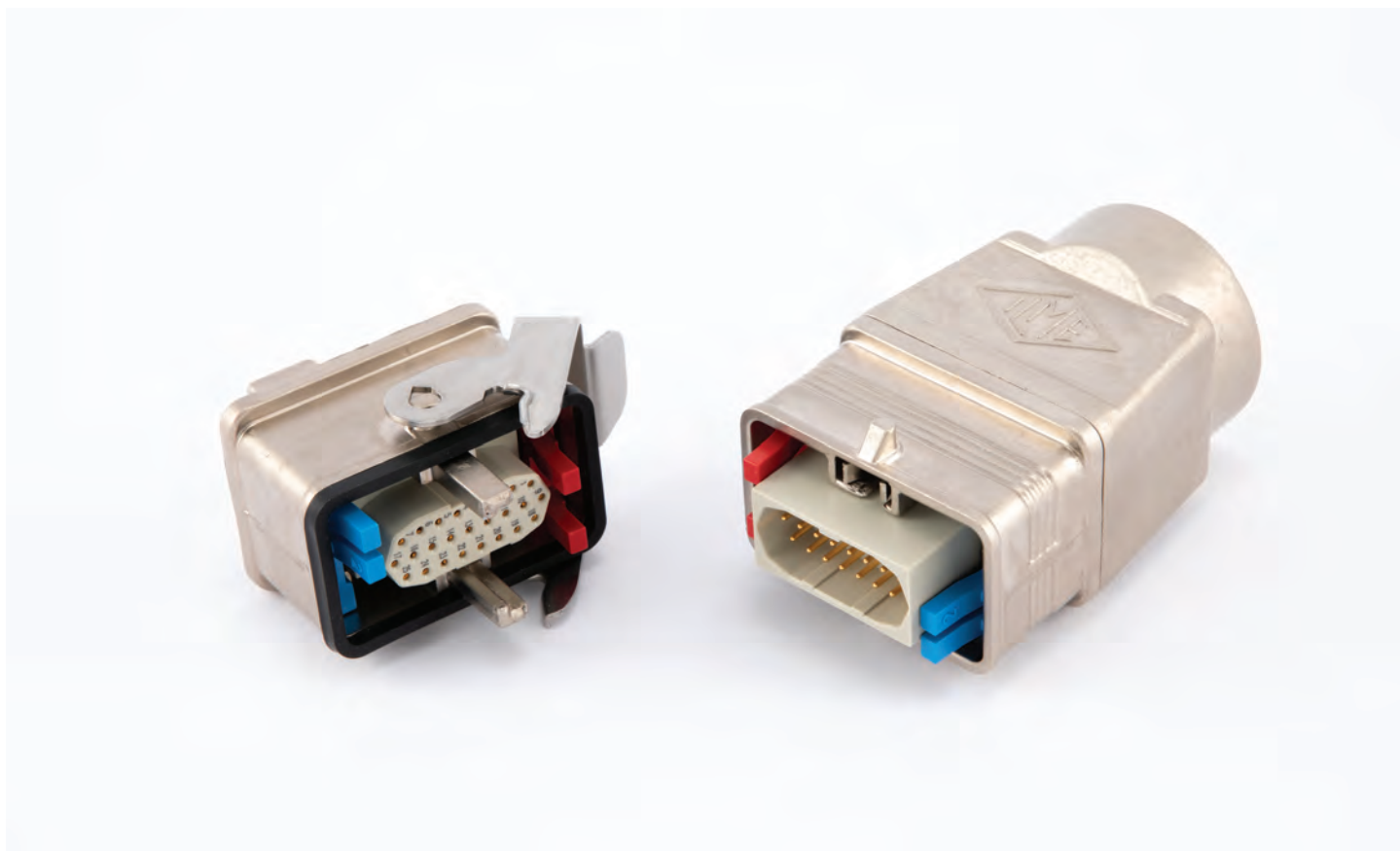

MIXO INSERTS

Gigabit 8 poles 5A - 50V

The modular inserts must be installed in suitable frames which are then mounted in traditional enclosures* or in COB panel support.
Single-sized modular units may be directly mounted inside MIXO ONE enclosures.

frames for modular units* page:
316 - 317

MIXO ONE enclosures 369

* enclosures: bulkhead mounting housings, high construction housings or high construction hoods

- we recommend the use of CRF / CRM code pins together with relevant MIXO frame

modular units, crimp connections

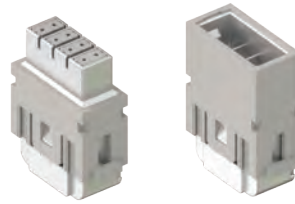

cable clamp



description

part No.

part No.

without contacts (to be ordered separately)
female insert for female contacts
male insert for male contacts

CX 08 I6F
CX 08 I6M

cable clamp for 5-7 mm cable diameter
cable clamp for 7-10 mm cable diameter
cable clamp for 10-12 mm cable diameter

CX 5/7 CA
CX 7/10 CA
CX 10/12 CA

- characteristics according to EN 61984:
5A 50V 0,8kV 3
- (UL for USA and Canada) certified, CSA, CQC, DNV-GL, BV pending
- rated voltage according to UL/CSA: 50V
- insulation resistance: $\geq 10 \text{ G}\Omega$
- ambient temperature limit: $-40 \text{ }^\circ\text{C} \dots +85 \text{ }^\circ\text{C}$
- suitable for bus signals, in particular for Ethernet Cat. 6A (Gigabit)
- shield electrically separated from the PE of the housings
- made of self-extinguishing thermoplastic resin UL 94V-0
- mechanical life: ≥ 500 cycles
- contact resistance: $\leq 4 \text{ m}\Omega$
- for crimp contacts CI series use:
CIPZ D crimping tool
CITP D turret head

CX 08 I6F, CX 08 I6M

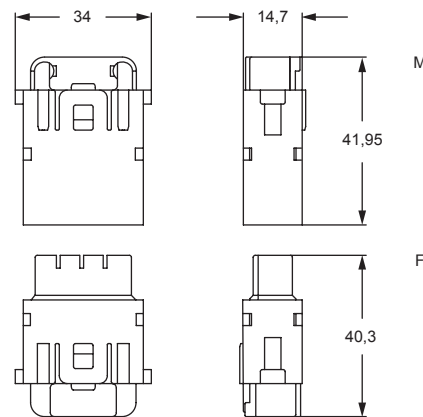

contacts side (front view)

side with reference arrow ▲

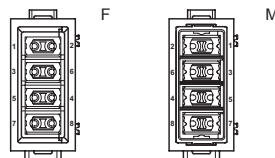

- 1 frame slot

CX 5/7 CA, CX 7/10 CA, CX 10/12 CA

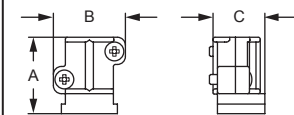

part No.	A	B	C
CX 5/7 CA	19,1	18	12,95
CX 7/10 CA	19,1	18	12,95
CX 10/12 CA	19,1	20,8	12,95

MIXO DATA



Watch
our
online
tutorial

**CI (5A) crimp contacts
gold plated**



description	part No.
-------------	----------

CI (5A) female crimp contacts
 0,08-0,21 mm² AWG 28-24
 0,13-0,33 mm² AWG 26-22
 0,33-0,52 mm² AWG 22-20

CIFD 0.2
CIFD 0.3
CIFD 0.5

gold plated

CI (5A) male crimp contacts
 0,08-0,21 mm² AWG 28-24
 0,13-0,33 mm² AWG 26-22
 0,33-0,52 mm² AWG 22-20

CIMD 0.2
CIMD 0.3
CIMD 0.5

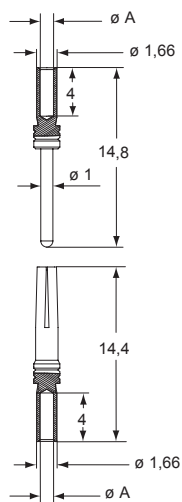

CIF and CIM contacts

conductor section (mm ²)	conductor slot ø A (mm)	conductors stripping length (mm)
0,08-0,21	0,64	4
0,13-0,33	0,90	4
0,33-0,52	1,12	4

MIXO DATA

CX 02 BF/BM 2 seats for connector 1 pole + shield

The modular inserts must be installed in suitable frames, which are then mounted in traditional enclosures* or in COB panel supports.

frames for modular units*

page:
316

* enclosures: bulkhead mounting housings, high construction housings or high construction hoods

modular units,
2-seat holder for shielded connectors

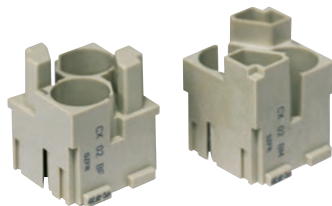

earthing adapter



description

part No.

part No

2-seat holder for shielded connectors
female insert, two seats for BUS connectors
male insert, two seats for BUS connectors
earthing adapter (optional)

CX 02 BF
CX 02 BM

CR GND

- characteristics according to EN 61984:
50V 0,8kV 3
- certified
- rated voltage according to UL/CSA: 50V
- insulation resistance: $\geq 10 \text{ G}\Omega$
- ambient temperature limit: $-40 \text{ }^\circ\text{C} \dots +125 \text{ }^\circ\text{C}$
- made of self-extinguishing thermoplastic resin
UL 94V-0
- suitable to hold in place any combination of up to two shielded connectors **CX 01 BC** (page 289), **CX 01 B** (page 291), **CX 04 B** (page 291) or **CX 08 B** (page 293)
- both the female and the male inserts may accept a combination of up to two shielded connectors of any gender, as far as the correct specular assignment is set on the mating connector
- extraction tool for BUS shielded connectors from MIXO BUS insert part No. **CX BES** see page 703



contacts side (front view)

side with reference arrow ▲

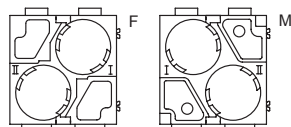

- 2 frame slots

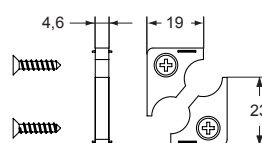

USE OF THE CR GND EARTHING ADAPTER

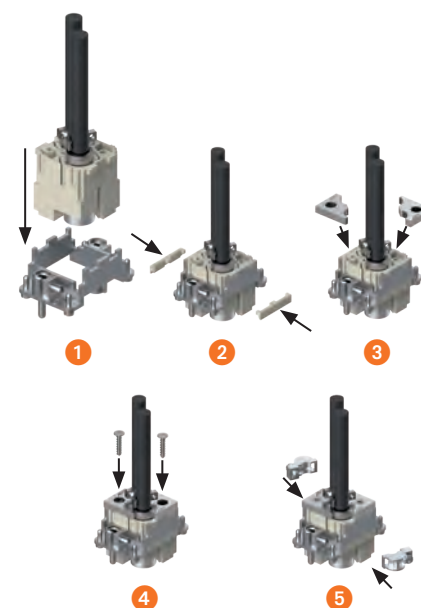

Note:
The shielded connectors have their shield insulated from the enclosure's earthing point.
If you wish to earth-connect the shield, install on the panel an anchorage for shielded cables **CR..ST** (see page 678) or the **CR GND** earthing adapter.



Watch
our
online
tutorial

CX 01 BCF/BCM 1 pole + shield (each connector) 16A - 50V

- characteristics according to EN 61984:
CX 01 BC shielded connector
16A 50V 0,8kV 3
- certified
- rated voltage according to UL/CSA: 50V
- insulation resistance: $\geq 10 \text{ G}\Omega$
- ambient temperature limit: $-40 \text{ }^\circ\text{C} \dots +70 \text{ }^\circ\text{C}$
- contact resistance: $\leq 1 \text{ m}\Omega$
- mechanical life: ≥ 500 cycles
- for information on the crimping of contacts series CC (CX 01 BC shielded connector) and on the insertion/removal tools, see the section related to crimping tools (16A contacts, CCF and CCM series) on pages 708 - 741
- CX 01 BC shielded connector for **cable with a typical impedance of $50 \text{ }\Omega$** (attenuation see below)
- suitable for **CX 02 B** (MIXO 2-seat holder) or **CX 1/2 BD** ("21.21" 1-seat adapter insert)
- female and male shielded connectors fit both in female and in male holder / adapter insert

shielded connectors



16A crimp contacts, silver and gold plated



description	part No.	part No.	part No.
-------------	----------	----------	----------

shielded BUS coaxial connectors, 1 pole + shield female insert, one contact seat 16A (CCF) + shield male insert, one contact seat 16A (CCM) + shield

CX 01 BCF
CX 01 BCM

16A female crimp contacts

Area	AWG	Profile
0,14-0,37 mm ²	AWG 26-22	one groove with no grooves
0,5 mm ²	AWG 20	one groove (back side)
0,75 mm ²	AWG 18	one groove
1 mm ²	AWG 18	two grooves
1,5 mm ²	AWG 16	three grooves
2,5 mm ²	AWG 14	one wide groove
3 mm ²	AWG 12	with no grooves
4 mm ²	AWG 12	with no grooves

16A male crimp contacts

Area	AWG	Profile
0,14-0,37 mm ²	AWG 26-22	one groove with no grooves
0,5 mm ²	AWG 20	one groove (back side)
0,75 mm ²	AWG 18	one groove
1 mm ²	AWG 18	two grooves
1,5 mm ²	AWG 16	three grooves
2,5 mm ²	AWG 14	one wide groove
3 mm ²	AWG 12	with no grooves
4 mm ²	AWG 12	with no grooves

Part No.	Plating	Part No.	Plating
CCFA 0.3	silver plated	CCFD 0.3	gold plated+
CCFA 0.5		CCFD 0.5	
CCFA 0.7		CCFD 0.7	
CCFA 1.0		CCFD 1.0	
CCFA 1.5		CCFD 1.5	
CCFA 2.5		CCFD 2.5	
CCFA 3.0		CCFD 3.0	
CCFA 4.0	CCFD 4.0		
CCMA 0.3	silver plated	CCMD 0.3	gold plated+
CCMA 0.5		CCMD 0.5	
CCMA 0.7		CCMD 0.7	
CCMA 1.0		CCMD 1.0	
CCMA 1.5		CCMD 1.5	
CCMA 2.5		CCMD 2.5	
CCMA 3.0		CCMD 3.0	
CCMA 4.0	CCMD 4.0		

CX 01 BCF, CX 01 BCM

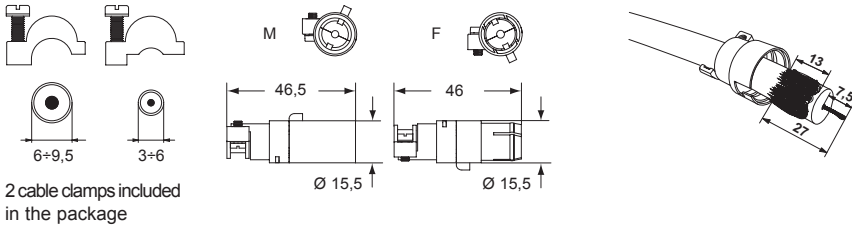

2 cable clamps included in the package

Test performed in accordance with IEC/EN 60512-25-2 (2002), 4.1.3.2 (coaxial cable only) and 4.2.2.2 (coaxial cable and connector).

Attenuation (insertion loss) 50 ohm coaxial connector (CX 01 BCF / BCM)

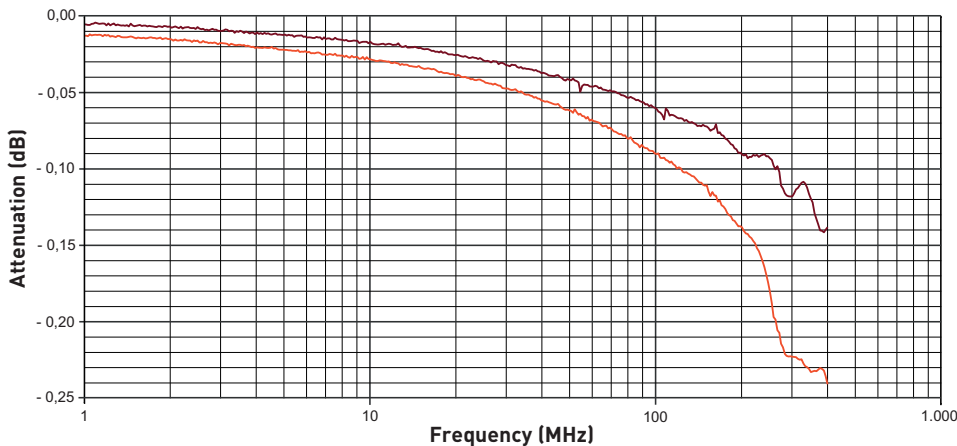

- RG 213/U cable and CX 01 BC connector (50 ohm)
- RG 213/U cable (50 ohm)

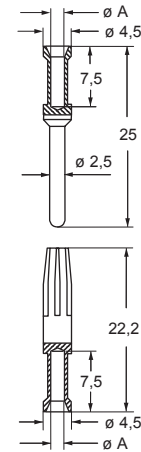

CCF and CCM contacts

conductor section (mm ²)	conductor slot ø A (mm)	conductors stripping length (mm)
0,14-0,37	0,9	7,5
0,5	1,1	7,5
0,75	1,3	7,5
1,0	1,45	7,5
1,5	1,8	7,5
2,5	2,2	7,5
3	2,55	7,5
4	2,85	7,5

+ for basic or high thickness gold plating, please refer to page 675

CX 02 BF/BM 2 seats for connector 1 or 4 poles + shield

The modular inserts must be installed in suitable frames, which are then mounted in traditional enclosures* or in COB panel supports.

frames for modular units*

page:
316

* enclosures: bulkhead mounting housings, high construction housings or high construction hoods

modular units,
2-seat holder for shielded connectors

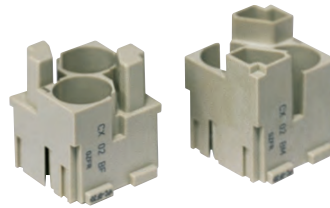

earthing adapter



description

part No.

part No

2-seat holder for shielded connectors
female insert, two seats for BUS connectors
male insert, two seats for BUS connectors
earthing adapter (optional)

CX 02 BF
CX 02 BM

CR GND

- characteristics according to EN 61984:
50V 0,8kV 3
- certified
- rated voltage according to UL/CSA: 50V
- insulation resistance: $\geq 10 \text{ G}\Omega$
- ambient temperature limit: $-40 \text{ }^\circ\text{C} \dots +125 \text{ }^\circ\text{C}$
- made of self-extinguishing thermoplastic resin
UL 94V-0
- suitable to hold in place any combination of up to two shielded connectors **CX 01 BC** (page 289), **CX 01 B** (page 291), **CX 04 B** (page 291) or **CX 08 B** (page 293)
- both the female and the male inserts may accept a combination of up to two shielded connectors of any gender, as far as the correct specular assignment is set on the mating connector
- extraction tool for BUS shielded connectors from MIXO BUS insert part No. **CX BES** see page 703

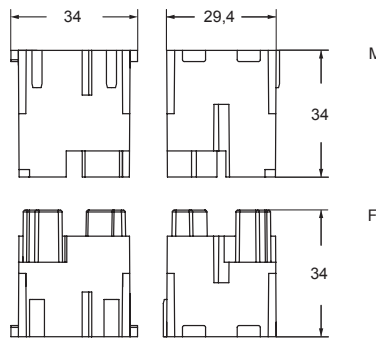

contacts side (front view)

side with reference arrow ▲

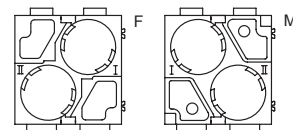

- 2 frame slots

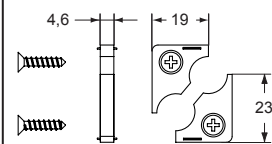

USE OF THE CR GND EARTHING ADAPTER

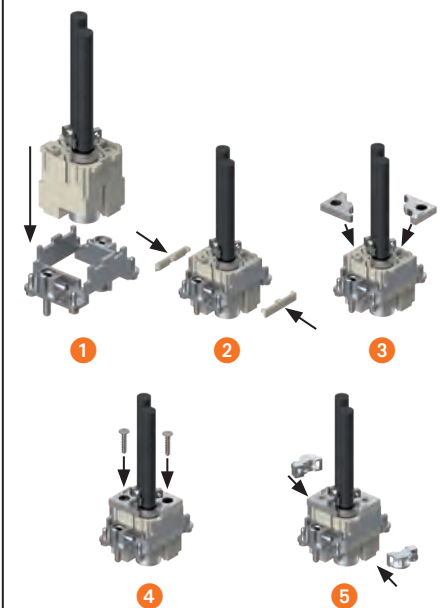

Note:
The shielded connectors have their shield insulated from the enclosure's earthing point.
If you wish to earth-connect the shield, install on the panel an anchorage for shielded cables **CR..ST** (see page 678) or the **CR GND** earthing adapter.

CX 01 BF/BM - CX 04 BF/BM 1 or 4 poles + shield (each connector) 10A - 50V

- characteristics according to EN 61984:
CX 04 B / CX 01 B shielded connector
10A 50V 0,8kV 3
- certified
- rated voltage according to UL/CSA: 50V
- insulation resistance: $\geq 10 \text{ G}\Omega$
- ambient temperature limit: $-40 \text{ }^\circ\text{C} \dots +85 \text{ }^\circ\text{C}$
- mechanical life: ≥ 500 cycles
- contact resistance:
shielded connector CX 04 B: $\leq 3 \text{ m}\Omega$
coaxial connector CX 01 B: $\leq 3 \text{ m}\Omega$
- for contact crimping instructions, refer to the crimping tool section (10A contacts, CDF and CDM series) on pages 708 - 741
- coaxial connector CX 01 B cables with a typical impedance of 75Ω (attenuation see below)
- CX 04 B multi axial connector for STP cables with 2 pairs and terminations compliant with EN 50173-1 Cat. 5 (100 MHz), compatible with 4-wire field bus protocols
- suitable for CX 02 B (MIXO 2-seat holder) or CX 1/2 BD ("21.21" 1-seat adapter insert)
- female and male shielded connectors fit both in female and in male holder / adapter insert

shielded connectors



10A crimp contacts, silver and gold plated



description	part No.	part No.	part No.
shielded BUS coaxial connectors, 1 pole + shield female insert, one contact seat 10A (CDF) + shield male insert, one contact seat 10A (CDM) + shield	CX 01 BF CX 01 BM		
shielded BUS multi axial connectors, 4 poles + shield female insert, four contact seats 10A (CDF) + shield male insert, four contact seats 10A (CDM) + shield	CX 04 BF CX 04 BM		
10A female crimp contacts			
0,14-0,37 mm ² AWG 26-22 identification No. 1		CDFA 0.3	CDFD 0.3
0,5 mm ² AWG 20 identification No. 2		CDFA 0.5	CDFD 0.5
0,75 mm ² AWG 18 identification No. ②		CDFA 0.7	CDFD 0.7
1 mm ² AWG 18 identification No. 3		CDFA 1.0	CDFD 1.0
1,5 mm ² AWG 16 identification No. 4		CDFA 1.5	CDFD 1.5
2,5 mm ² AWG 14 identification No. 5		CDFA 2.5	CDFD 2.5
10A male crimp contacts			
0,14-0,37 mm ² AWG 26-22 identification No. 1		CDMA 0.3	CDMD 0.3
0,5 mm ² AWG 20 identification No. 2		CDMA 0.5	CDMD 0.5
0,75 mm ² AWG 18 identification No. ②		CDMA 0.7	CDMD 0.7
1 mm ² AWG 18 identification No. 3		CDMA 1.0	CDMD 1.0
1,5 mm ² AWG 16 identification No. 4		CDMA 1.5	CDMD 1.5
2,5 mm ² AWG 14 identification No. 5		CDMA 2.5	CDMD 2.5

CX 01 BF, CX 01 BM

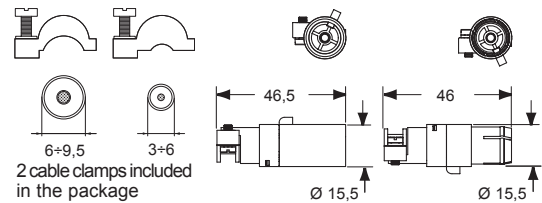

CX 04 BF, CX 04 BM

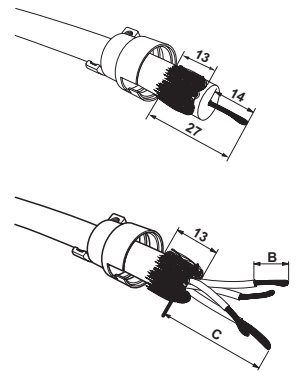
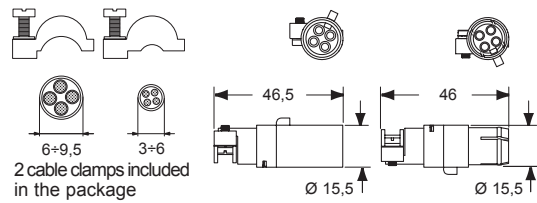

Test performed in accordance with IEC/EN 60512-25-2 (2002), 4.1.3.2 (coaxial cable only) and 4.2.2.2 (coaxial cable and connector).

Attenuation (insertion loss) 75 ohm coaxial connector (CX 01 BF / BM)

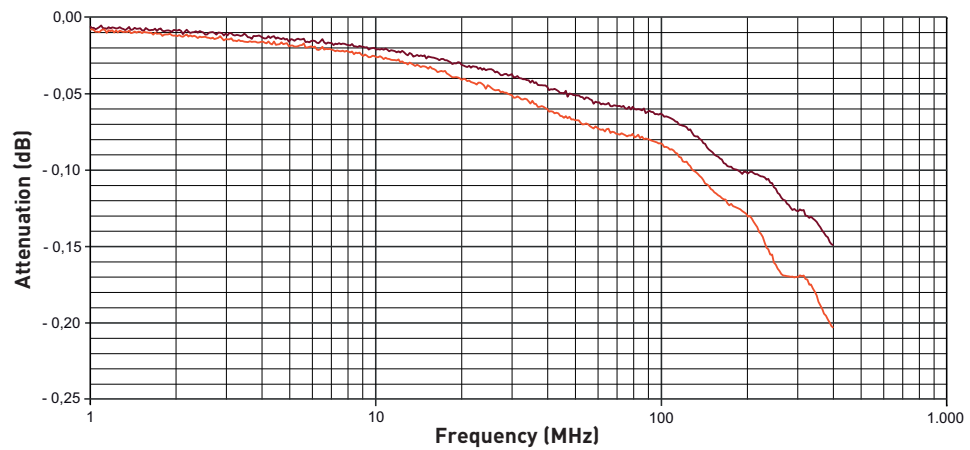

— RG 11 A/U cable and CX 01 B connector (75 ohm)
— RG 11 A/U cable (75 ohm)

cable clamp	C (mm)
3-6	20
6-9,5	25

CDF and CDM contacts		
conductor section	conductor slot	conductors stripping length
(mm ²)	$\varnothing A$ (mm)	B (mm)
0,14-0,37	0,9	8
0,5	1,1	8
0,75	1,3	8
1,0	1,45	8
1,5	1,8	8
2,5	2,2	6

‡ for basic or high thickness gold plating, please refer to page 674

CX 02 BF/BM 2 seats for connector 8 poles + shield

The modular inserts must be installed in suitable frames, which are then mounted in traditional enclosures* or in COB panel supports.

frames for modular units*

page:
317

* enclosures: bulkhead mounting housings, high construction housings or high construction hoods

modular units,
2-seat holder for shielded connectors

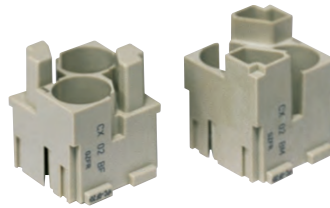

earthing adapter

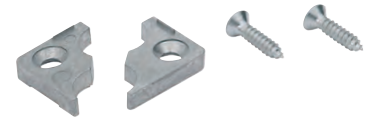

description	part No.	part No
-------------	----------	---------

2-seat holder for shielded connectors
female insert, two seats for BUS connectors
male insert, two seats for BUS connectors
earthing adapter (optional)

CX 02 BF
CX 02 BM

CR GND

MIXO DATA

- characteristics according to EN 61984:
50V 0,8kV 3
- certified
- rated voltage according to UL/CSA: 50V
- insulation resistance: $\geq 10 \text{ G}\Omega$
- ambient temperature limit: $-40 \text{ }^\circ\text{C} \dots +125 \text{ }^\circ\text{C}$
- made of self-extinguishing thermoplastic resin UL 94V-0
- suitable to hold in place any combination of up to two shielded connectors **CX 01 BC** (page 289), **CX 01 B** (page 291), **CX 04 B** (page 291) or **CX 08 B** (page 293)
- both the female and the male inserts may accept a combination of up to two shielded connectors of any gender, as far as the correct specular assignment is set on the mating connector
- extraction tool for BUS shielded connectors from MIXO BUS insert part No. **CX BES** see page 703

Note:
The shielded connectors have their shield insulated from the enclosure's earthing point.
If you wish to earth-connect the shield, install on the panel an anchorage for shielded cables **CR..ST** (see page 678) or the **CR GND** earthing adapter.

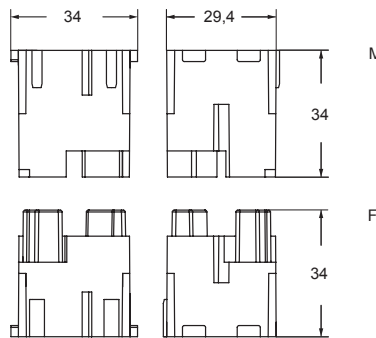

contacts side (front view)

side with reference arrow ▲

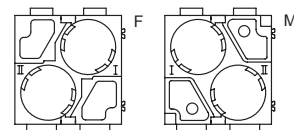

- 2 frame slots

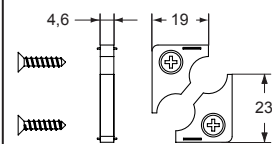

USE OF THE CR GND EARTHING ADAPTER

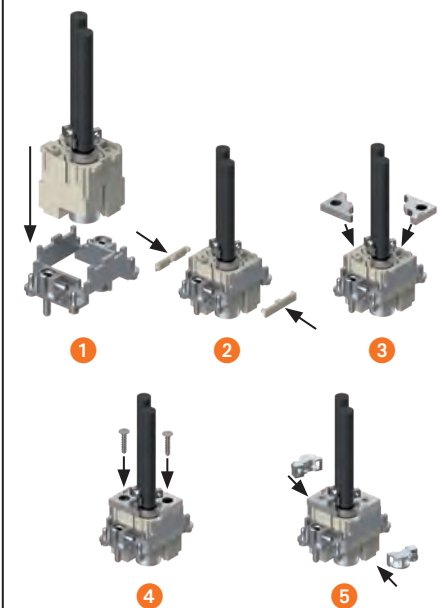

CX 08 BF/BM 8 poles + shield (each connector) 5A - 50V

shielded connectors



CI (5A) crimp contacts, silver and gold plated



description	part No.	part No.	part No.
-------------	----------	----------	----------

shielded BUS multi axial connectors, 8 poles + shield
 female insert, eight contact seats 5A (CIF) + shield
 male insert, eight contact seats 5A (CIM) + shield

CX 08 BF
CX 08 BM

CI (5A) female crimp contacts
 0,08-0,21 mm² AWG 28-24
 0,13-0,33 mm² AWG 26-22
 0,33-0,52 mm² AWG 22-20

CIFA 0.2
 CIFA 0.3
 CIFA 0.5

silver plated

CIFD 0.2
 CIFD 0.3
 CIFD 0.5

gold plated

CI (5A) male crimp contacts
 0,08-0,21 mm² AWG 28-24
 0,13-0,33 mm² AWG 26-22
 0,33-0,52 mm² AWG 22-20

CIMA 0.2
 CIMA 0.3
 CIMA 0.5

CIMD 0.2
 CIMD 0.3
 CIMD 0.5

- characteristics according to EN 61984:
 CX 08 B shielded connector

5A 50V 0,8kV 3

- certified
- rated voltage according to UL/CSA: 50V
- insulation resistance: ≥ 10 GΩ
- ambient temperature limit: -40 °C ... +85 °C
- mechanical life: ≥ 500 cycles
- contact resistance: ≤ 4 mΩ
- max. Ø of insulation for contacts CI series: 2,4 mm
- suitable for **CX 02 B** (MIXO 2-seat holder) or **CX 1/2 BD** ("21.21" 1-seat adapter insert)
- female and male shielded connectors fit both in female and in male holder / adapter insert
- for crimp 5A contacts CI series use:
CIPZ D crimping tool
CITP D turret head
CIES insertion / removal tool

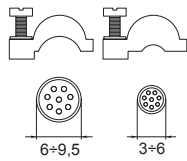

2 cable clamps included in the package

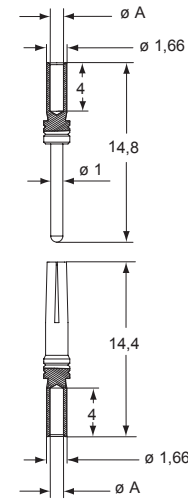
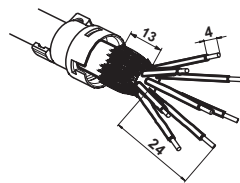
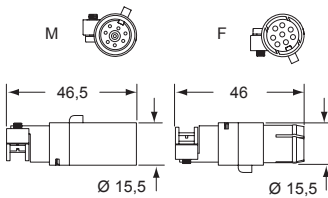

CIF and CIM contacts

conductor section (mm ²)	conductor slot Ø A (mm)	conductors stripping length (mm)
0,08-0,21	0,64	4
0,13-0,33	0,90	4
0,33-0,52	1,12	4

MIXO DATA

CX 01 UF/UM for 1 USB connector

The modular inserts must be installed in suitable frames which are then mounted in traditional enclosures* or in COB panel support.
Single-sized modular units may be directly mounted inside MIXO ONE enclosures.

frames for modular units* page: 316 - 317

MIXO ONE enclosures 369

* enclosures: bulkhead mounting housings, high construction housings or high construction hoods

module adapter for USB male connector, USB 2.0 female-female coupler

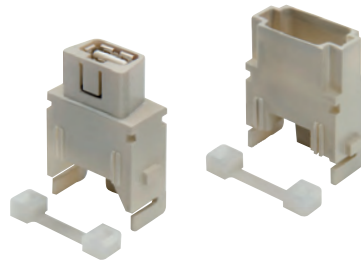

patch cable USB



description

part No.

part No.

female insert with USB 2.0 female-female coupler ¹⁾
male insert without USB male connector (patch cable to be ordered separately) ¹⁾

CX 01 UF
CX 01 UM

patch cable USB-A / USB-A, 2 m ²⁾

CW 2 UAM

²⁾ 5 m on request

- characteristics according to EN 61984:

1A 50V 0,8kV 3

- ¹⁾ cULus (UL for USA and Canada),

- Bureau Veritas certified

- insulation resistance: $\geq 10 \text{ G}\Omega$

- contact resistance: $\leq 3 \text{ m}\Omega$

USB connector features:

- USB-A / USB-A Hi-Speed - 2.0 insert

- temperature range: from $-25 \text{ }^\circ\text{C}$ to $+80 \text{ }^\circ\text{C}$

FIXING

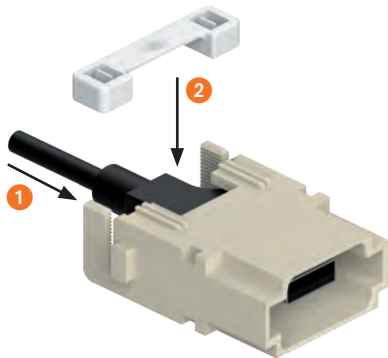

REOPENING

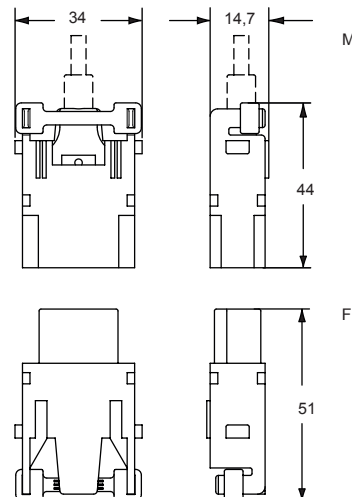
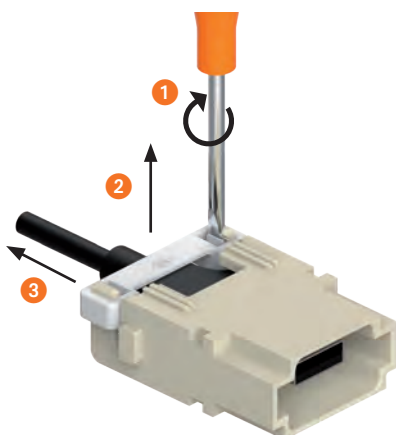

contacts side (front view)

side with reference arrow ▲

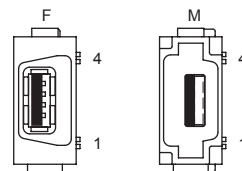

- 1 frame slot

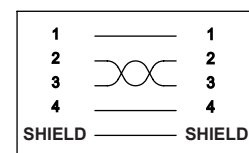
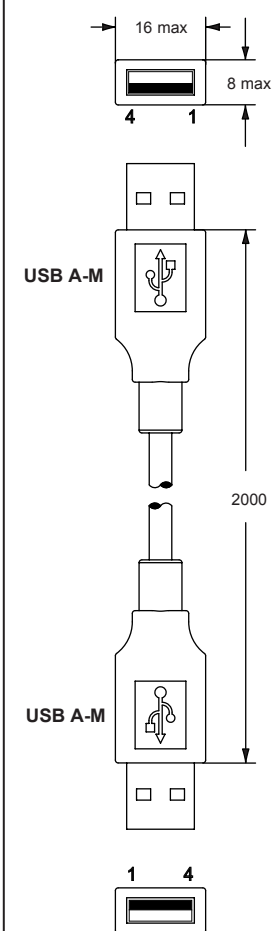

MIXO DATA



MIXO DATA

CX 01 9VF/9VM for 9-pole crimp D-SUB connector

The modular inserts must be installed in suitable frames which are then mounted in traditional enclosures* or in COB panel support.
Single-sized modular units may be directly mounted inside MIXO ONE enclosures.

frames for modular units* page: 316 - 317

MIXO ONE enclosures 369

* enclosures:
housings or high construction hoods

module adapter for 1 D-SUB connector



CI (5 A) crimp contacts for D-SUB gold plated



description	part No.	part No
-------------	----------	---------

seat for 1 D-SUB crimp contacts connector and shield (included)

female insert with connector
male insert with connector

CX 01 9VF
CX 01 9VM

CI (5 A) female crimp contacts
0,08-0,21 mm² AWG 28-24
0,13-0,33 mm² AWG 26-22
0,33-0,52 mm² AWG 22-20
0,52-0,75 mm² AWG 20-18

CIFD 0.2
CIFD 0.3
CIFD 0.5
CIFD 0.7

gold plated

CI (5 A) male crimp contacts
0,08-0,21 mm² AWG 28-24
0,13-0,33 mm² AWG 26-22
0,33-0,52 mm² AWG 22-20
0,52-0,75 mm² AWG 20-18

CIMD 0.2
CIMD 0.3
CIMD 0.5
CIMD 0.7

- characteristics according to EN 61984:

5 A 50 V 0,8 kV 3

- insulation resistance: $\geq 10 \text{ G}\Omega$
- ambient temperature limit: $-40 \text{ }^\circ\text{C} \dots +70 \text{ }^\circ\text{C}$
- mechanical life: ≥ 500 cycles
- contact resistance: $\leq 4 \text{ m}\Omega$
- for crimp 5 A contacts CI series use, on page 716:
CIPZ D crimping tool
CITP D turret head
CIVES insertion / removal tool
CIES B insertion / removal tool for size 0.7 contacts

Warnings:

We recommend the use of code pins
CRF CX / CRM CX (see pages 685 - 686)

CRF CX
CRM CX
code pins

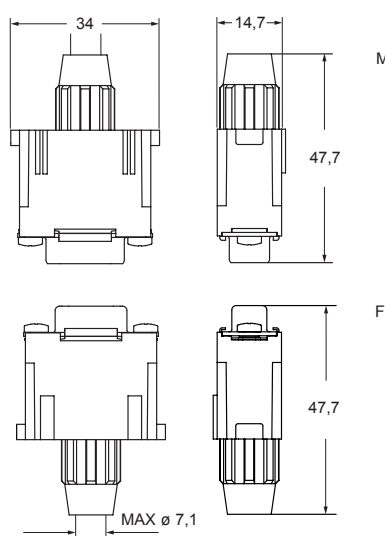

contacts side (front view)

side with reference arrow ▲

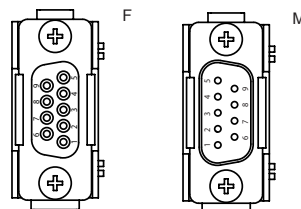

- 1 frame slot

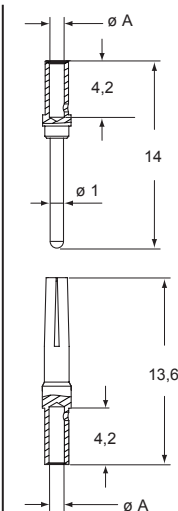

ALTERNATIVELY

	<p>- Seats for 1 D-SUB screw connectors (without shield):</p> <p>CX 01 9VFS (with female connectors) CX 01 9VMS (with male connectors)</p>
	<p>- Seat for 1 D-SUB connector (without connector and shield):</p> <p>CX 01 VM (for male connector) CX 01 VF (for female connector)</p> <p>Can also be used with 15-pole D-SUB Hi-Density connectors. For further information, please contact ILME S.p.A.</p>
	<p>- CR CX VS shield for CX 01 VM/VF inserts</p>

9-POLE FEMALE CRIMP D-SUB CONNECTOR (CAN BE USED WITH CX 01 VF)

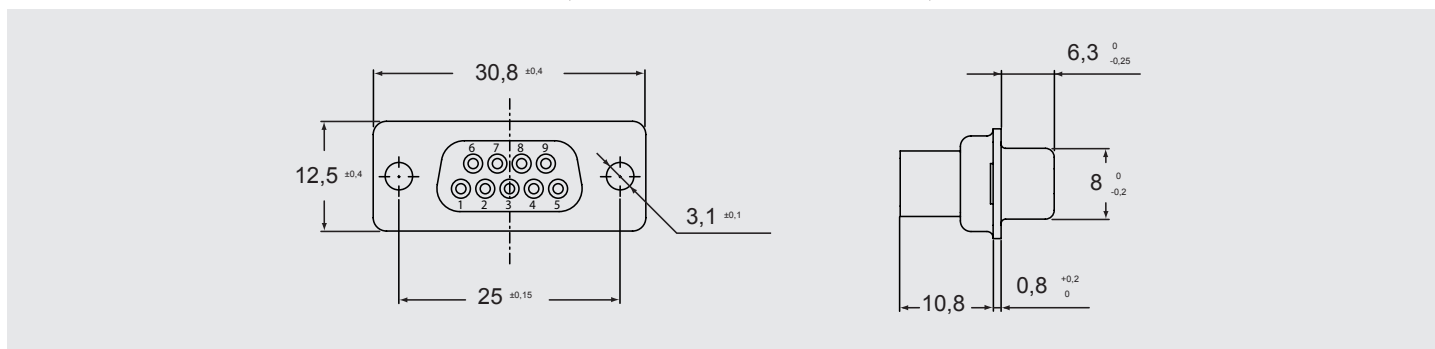

9-POLE MALE CRIMP D-SUB CONNECTOR (CAN BE USED WITH CX 01 VM)

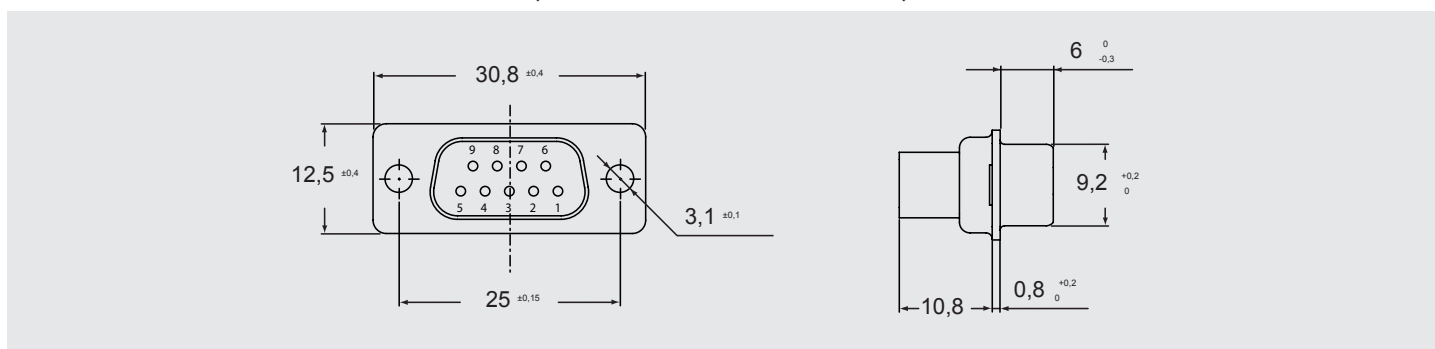

CX 01 9VTF 9-pole crimp D-SUB RS-485 BUS connector

The modular inserts must be installed in suitable frames which are then mounted in traditional enclosures* or in COB panel support.
Single-sized modular units may be directly mounted inside MIXO ONE enclosures.

frames for modular units* page: 316 - 317

MIXO ONE enclosures 369

* enclosures:
housings or high construction hoods

module adapter
for 1 D-SUB RS-485 connector



module adapter
for 1 D-SUB connector



description	part No.	part No
-------------	----------	---------

MIXO D-Sub 9-pole female module for RS-485 T-connection, with cable clamp accommodation for 2 cables

CX 01 9VTF

seat for 1 D-SUB crimp contacts connector and shield (included)
male insert with connector

CX 01 9VM

- characteristics according to EN 61984: **5A 50V 0,8kV 3**
- insulation resistance: $\geq 10 \text{ G}\Omega$
- ambient temperature limit: $-40 \text{ }^\circ\text{C} \dots +70 \text{ }^\circ\text{C}$
- mechanical life: ≥ 500 cycles
- contact resistance: $\leq 4 \text{ m}\Omega$
- "T" functionality with connection of two RS-485 bus cables (screw terminal)
- to be coupled with CX 01 9VM module
- for wires 0,14-0,5 mm² - 26-20 AWG
- cable screen max outer diameter 6 mm

Warnings:
We recommend the use of code pins
CRF CX / CRM CX (see pages 685 - 686)

CRF CX
CRM CX
code pins

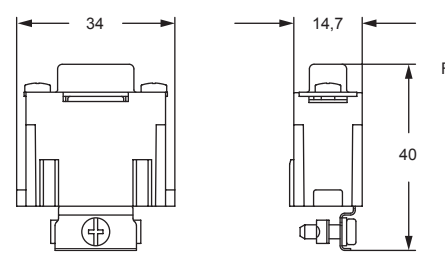

contacts side (front view)

side with reference arrow ▲

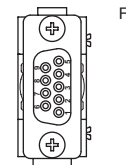

- 1 frame slot

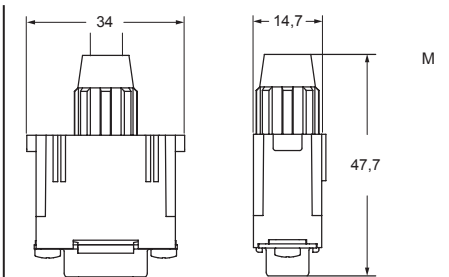

contacts side (front view)

side with reference arrow ▲

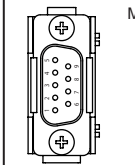

- 1 frame slot



Watch
our
online
tutorial

for 4 POF or MOST^{® 3)} contacts (DIN 41626-3)

The modular inserts must be installed in suitable frames which are then mounted in traditional enclosures or in COB panel support.
Single-sized modular units may be directly mounted inside MIXO ONE enclosures.

frames for modular units	page: 316 - 317
MIXO ONE enclosures	369

modular units, crimp connections

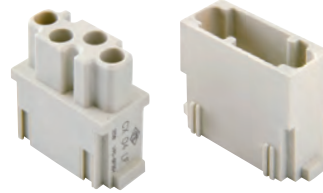

POF / MOST crimp contacts



description	part No.	part No.
without contacts (to be ordered separately)		
female inserts for female contacts ¹⁾	CX 04 LF	
male inserts for male contacts ¹⁾	CX 04 LM	
female contacts POF ²⁾ 1,0 mm		CX PLF
male contacts POF ²⁾ 1,0 mm		CX PLM
female contacts MOST ^{® 3)} 1/1,5 mm		CX MLF
male contacts MOST ^{® 3)} 1/1,5 mm		CX MLM

²⁾ POF = POLYMER OPTICAL FIBRE
³⁾ MOST[®] = MEDIA ORIENTED SYSTEM TRANSPORT
MOST[®] is a registered trade mark of Microchip Technology Inc.

- cULus (UL for USA and Canada), certified ¹⁾
- insulation resistance: ≥ 1 GΩ
- ambient temperature limit: -40 °C ... +85 °C
- inserts made of self-extinguishing thermoplastic resin UL 94V-0
- mechanical life: ≥ 500 cycles
- contact resistance: ≤ 30 mΩ
- for crimp contacts CI series use:
CIPZ D crimping tool
CITP D turret head
- max external diameter: 2,2 mm (POF)
2,3 mm (MOST)
- polymer fibre diameter: 1,0 mm (POF)
1/1,5 mm (MOST)
- attenuation: < 2.5 dB
- to crimp contacts CX PLF / PLM and CX MLF / MLM please use tool CLPZ R (see the crimping tool section on page 730)

We recommend to use CLASS enclosures with two levers or V-TYPE enclosures (with one or two levers) that provides a higher coupling depth due to the higher locking force they produce. We further suggest the use of code pins CRF CX / CRM CX (see pages 685 - 686).

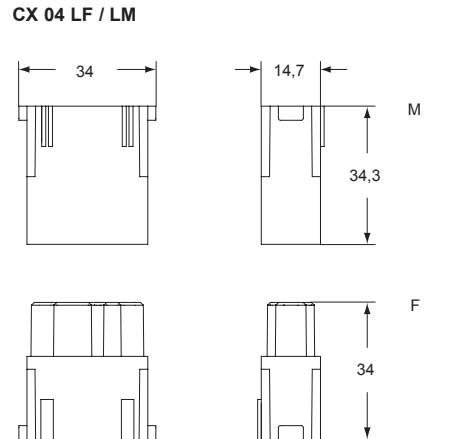
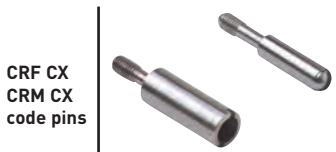

contacts side (front view)

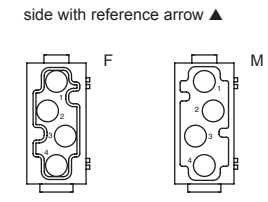

- 1 frame slot

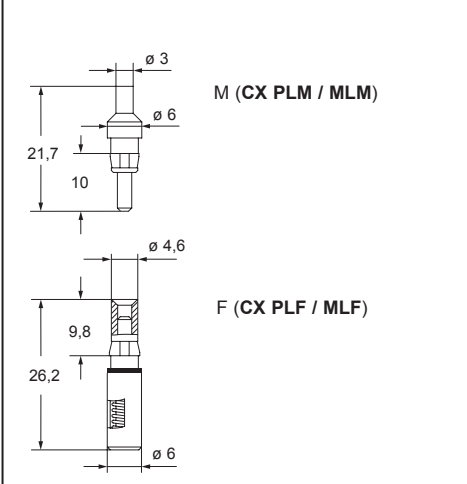

cable stripping for fibre optic

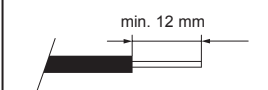

male contact

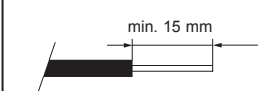

female contact

MIXO DATA

for 4 coaxial contacts DIN 41626-T2

The modular inserts must be installed in suitable frames which are then mounted in traditional enclosures or in COB panel support.
Single-sized modular units may be directly mounted inside MIXO ONE enclosures.

frames for modular units page: 316 - 317
MIXO ONE enclosures 369

modular units, crimp connections

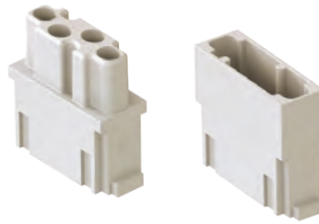

crimp coaxial contacts



description	part No.	part No.
without contacts (to be ordered separately)		
female inserts for female contacts	CX 04 RF	
male inserts for male contacts	CX 04 RM	
female coaxial contacts 50Ω		CX 50 RF
male coaxial contacts 50Ω		CX 50 RM
female coaxial contacts 75Ω		CX 75 RF
male coaxial contacts 75Ω		CX 75 RM

- characteristics according to EN 61984:
1,5A 50V 0,8kV 3
- (UL for USA and Canada), certified
- insulation resistance: $\geq 5 \text{ G}\Omega$
- temperature range: $-40 \text{ }^\circ\text{C} \dots +125 \text{ }^\circ\text{C}$
- inserts are made of self-extinguishing thermoplastic resin UL 94V-0
- mechanical life: ≥ 500 cycles
- in accordance with standard DIN 41626-T2
- finishing:
contact surfaces, body, back end and ferrule gold plated
- impedance: $50 \text{ }\Omega$
- frequency: DC to 6 GHz
- return loss: $\geq 21 \text{ dB}$, DC to 2 GHz
 $\geq 19 \text{ dB}$, 2 to 6 GHz
- insertion loss: $\leq 0,1 \times \sqrt{f(\text{GHz})} \text{ dB}$
- center contact resistance: $\leq 10 \text{ m}\Omega$
- outer contact resistance: $\leq 3 \text{ m}\Omega$
- test voltage: 750V rms
- working voltage: 250V rms
- RF-leakage: $\geq 80 \text{ dB}$ up to 0,5 GHz
 $\geq 65 \text{ dB}$ up to 1,5 GHz
- to crimp contacts CX 50 RM/RF, CX 75 RM/RF use tool COPZ R (see the crimping tool section on page 734)

CX 04 RF / RM

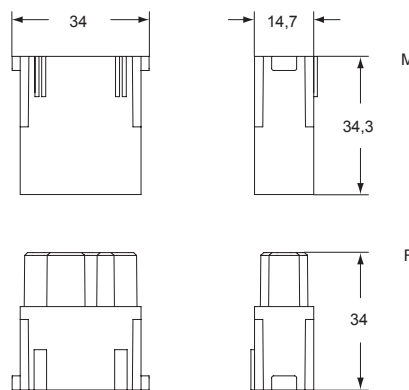

contacts side (front view)

side with reference arrow ▲

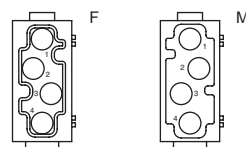

- 1 frame slot

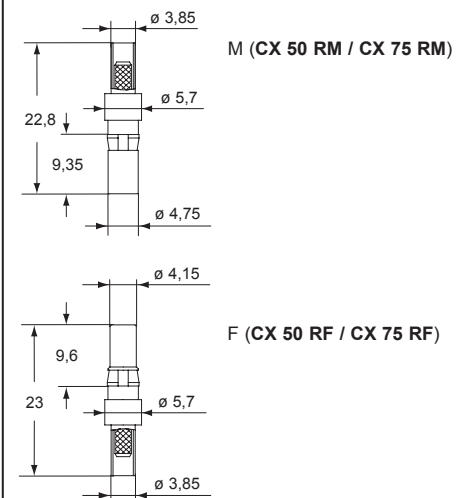

conductor stripping

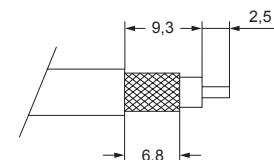

Warnings:

We recommend the use of code pins
CRF CX / CRM CX (see pages 685 - 686)

CRF CX
CRM CX
code pins



coaxial contacts	for cables	ø external	part No.
50Ω	RG 316/U	2,49 $\pm 0,1$	CX 50 RF
	RG 174/U	2,79 $\pm 0,127$	CX 50 RM
	RG 188 A/U	2,79 max	
75Ω	RG 179 B/U	2,54 $\pm 0,127$	CX 75 RF
	RG 187 A/U	2,79 max	CX 75 RM
	TZC 75 101	2,79 max	

4 seats for fibre optic SC contacts

The modular inserts must be installed in suitable frames which are then mounted in traditional enclosures or in COB panel support.
Single-sized modular units may be directly mounted inside MIXO ONE enclosures.

frames for modular units	page: 316 - 317
MIXO ONE enclosures	369

WARNING:
inserts can be used on high enclosures or bulkhead housings only.

module adapter for SC connectors

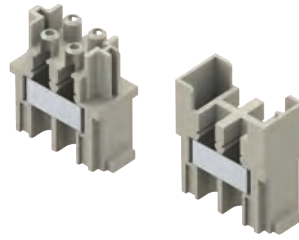

crimp FO contacts



description	part No.	part No.
module insert with seats for 4 SC contacts (metal fixing plate included) female insert, with ceramic sleeve female insert, with metallic sleeve male insert	CX 04 SCF CX 04 SCF-H CX 04 SCM	CL 125 SC CL POF SC
SC contact for GI ¹⁾ FIBRE 50/125 µm or 62.5/125 µm SC contact for ø POF 1 mm		

¹⁾ GI = Graded Index

- (UL for USA and Canada), certified
- insulation resistance: ≥ 10 GΩ
- temperature range: from -40 °C to +85 °C
- made of self-extinguishing thermoplastic resin UL 94V-0
- mechanical life: ≥ 500 cycles
- adapter insert fitted with metal plate and sleeve (female only) fixing

CX 04 SC

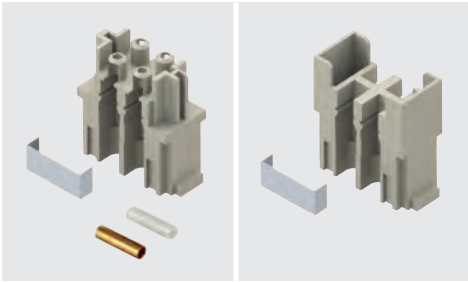

- adapter insert designed to be used with SC contacts
- SC contact for SI ²⁾ FIBRE (HCS_s) 200/230 µm:
CL 230 SC (on request)
- ²⁾ SI = Step Index
- base equipment for SC contact GI FIBRE:
CLKZ 125 SC
If this application is required, please contact ILME S.p.A.
- supplementary set for POF:
CLKZ POF
(to be ordered with CLKZ 125 SC)
If this application is required, please contact ILME S.p.A.

SC duplex patch cord

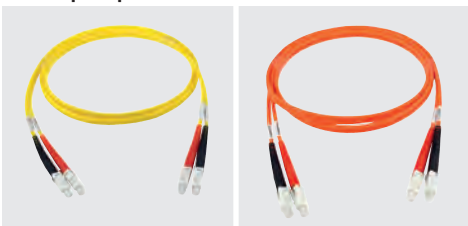

CW SC from page 240

CX 04 SCF, CX 04 SCF-H, CX 04 SCM

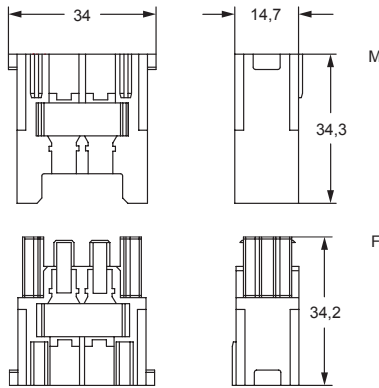

contacts side (front view)

side with reference arrow ▲

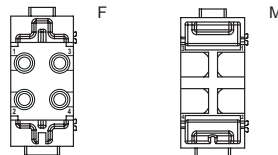

- 1 frame slot

CL 125 SC

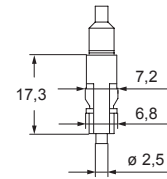

CL POF SC

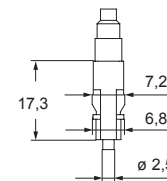



for 1 RJ45 Cat. 6 Class E_A

The modular inserts must be installed in suitable frames, which are then mounted in traditional enclosures or in COB panel supports.

frames for modular units page:
316 - 317

MIXO ONE enclosures 369

- characteristics according to EN 61984:
- 1A 50V 0,8kV 3**
- certified by  (UL for USA and Canada),  
- ENEC certified
- rated voltage according to UL/CSA: 50V
- insulation resistance: ≥ 10 GΩ
- made of self-extinguishing thermoplastic resin UL 94V-0
- mechanical life: ≥ 500 cycles
- contact resistance: ≤ 3 mΩ
- temperature range: from -40 °C to +85 °C
- we recommend to fix the cable with cable tie
- for contact crimping instructions, please see the crimping tool section on page 736 and 737

module adapters for RJ45 male connector, female insert with RJ45 female-female coupler

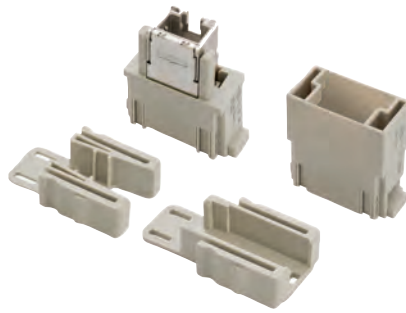

crimp and IDC termination, RJ45 male connectors



description	part No.	part No.
- female insert with 1 RJ45 female-female coupler - male insert for 1 RJ45 male crimp connector, (without RJ45 connector, to be ordered separately) or connecting cables - male insert for 1 RJ45 male IDC connector, 8 data contacts (without RJ45 connector, to be ordered separately) ¹⁾	CX 01 J8F CX 01 J8M	
RJ45 male crimp connector, 8 data contacts		CX 8 J6M
RJ45 male IDC connector, 8 data contacts		CX 8 J6IM

- CX 01 J8F technical data:**
- RJ45 female insert, Cat. 6 Class E_A
 - shielding housing: zinc diecast
 - housing finish: nickel-plated
 - current carrying capacity at 50 °C: 1A
 - adequate for Power over Ethernet: PoE according to IEEE 802.3af
 - connectors: IEC 60603-7-5
 - adequate for 10 Gigabit Ethernet: 10 Gigabit Ethernet acc. to IEEE 802.3an
 - custom-designed cabling systems: PROFINET Installation Guideline
 - generic cabling systems: ANSI/TIA/EIA-568-C.2
 - ISO/IEC 11801
 - EN 50173-1
 - ISO/IEC 24702
 - EN 61918
 - Class E_A (channel): ISO/IEC 11801, EN 50173-1

- CX 8 J6M technical data:**
- RJ45 male crimp connectors Cat. 6_A
 - crimp pliers: **CJPZ T**
 - screened cable stripper: **CJST**
 - current carrying capacity at 50 °C: 1A
 - Cu-conductor diameter solid: 0,40 - 0,51 mm (AWG 26/1 - 24/1)
 - stranded: 0,46 - 0,61 mm (AWG 27/7 - 24/7)
 - insulation diameter: 0,85 - 1,05 mm
 - cable diameter: 5,0 - 6,6 mm
 - connectors: IEC 60603-7-51
 - 10 Gigabit Ethernet acc. to IEEE 802.3an: adequate for 10 Gigabit Ethernet
 - category 6_A: ISO/IEC 11801; EN 50173-1
 - Class E_A: ISO/IEC 11801; EN 50173-1
 - Category 6_A: ANSI/TIA/EIA-568-C.2

- CX 8 J6IM technical data:**
- RJ45 male IDC connectors Cat. 6 Class E_A
 - Cu-conductor diameter solid: 0,41 - 0,64 mm (AWG 26/1 - 22/1)
 - stranded: 0,48 - 0,76 mm (AWG 26/7 - 22/7)
 - insulation diameter: 0,85 - 1,6 mm
 - current carrying capacity at 50 °C: 1A
 - cable diameter: 5,5 - 7,3 mm
 - connectors: IEC 60603-7-5
 - category 6_A: ISO/IEC 11801; DIN EN 50173-1
 - wrenches pliers for CX 8 J6IM: **CJPW K**
 - 10 Gigabit Ethernet acc. to IEEE 802.3an: adequate for 10 Gigabit Ethernet
 - Class E_A: ISO/IEC 11801; EN 50173-1
 - Category 6: ANSI/TIA/EIA-568-C.2
 - custom-designed cabling systems: according to PROFINET Installation Guideline

WARNING:
inserts can be used on high enclosures or bulkhead housings only.

¹⁾ CX 01 J8IM: to be used with high enclosures (T-TYPE hood M32 / M40 only and CZAV/MZAV top entry hood only), bulkhead housings or COB ... BC/TCQ/TSF/ TSFS only.

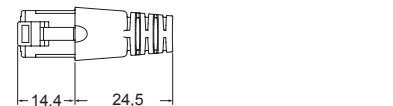
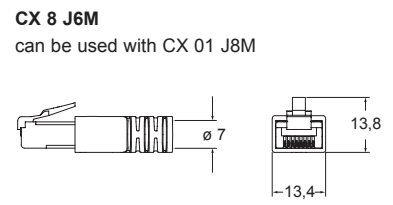
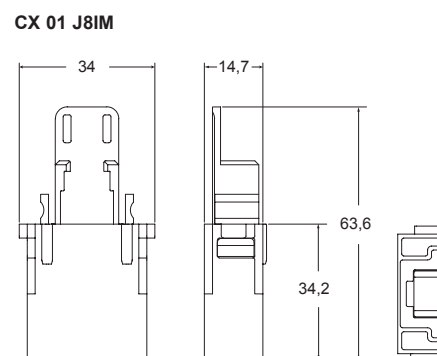
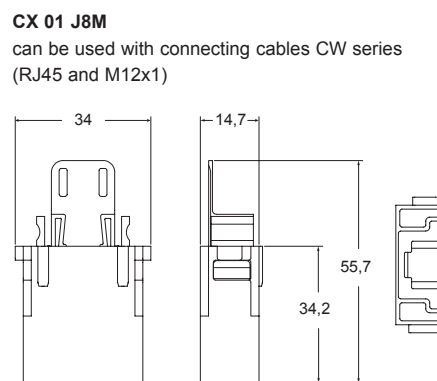
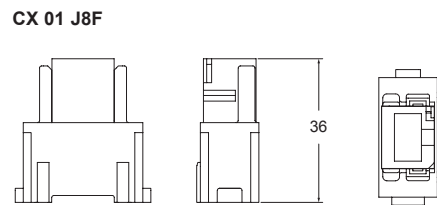

for free cable end X-coded DTW X...W (M12x1)

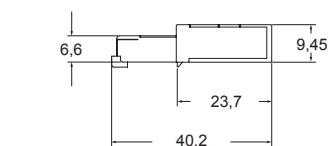
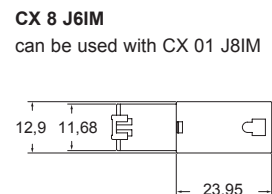

for free cable end X-coded DTW...W (M12x1)

CW RJ45 patch cord

with 2 RJ45 male connectors



description	part No.	(L) meter
RJ45 male connector with 8 data contacts	CW 1 J2M87	1
	CW 2 J2M87	2
	CW 3 J2M87	3
	CW 5 J2M87	5
	CW 7.5J2M87	7,5
	CW 10 J2M87	10
	CW 15 J2M87	15

RJ45 patch cord technical data:
 - S/FTP Cat. 7 PUR
 - temperature range: from -40 °C + +75 °C
 - nickel plated brass screening
 - green RAL 6018 colour

Can be used with:
 - MIXO RJ45 **CX 01 J8M** male inserts
 - **CJK 8MT** adapters (see page 226)

CW...J2M87

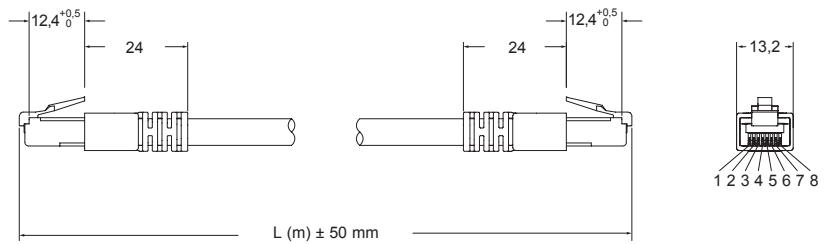

Wiring Diagram

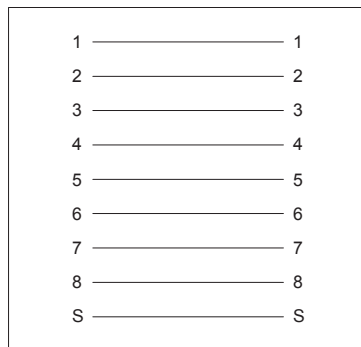

MIXO DATA

for 1 RJ45 + 4 poles connector 10A - 250V

The modular inserts must be installed in suitable frames, which are then mounted in traditional enclosures or in COB panel supports.

page: 316

frames for modular units

- characteristics according to EN 61984:

10A 250V 4kV 3

- (UL for USA and Canada),

certified

- insulation resistance: $\geq 10 \text{ G}\Omega$

- made of self-extinguishing thermoplastic resin UL 94V-0

- mechanical life: ≥ 500 cycles

- contact resistance: $\leq 3 \text{ m}\Omega$

- **it is recommended to crimp the contacts with crimping tools homologated by ILME** (please see the crimping tool section 10A contacts, CDF and CDM series) on pages 708 - 741

housing for RJ45 + 4 poles connector

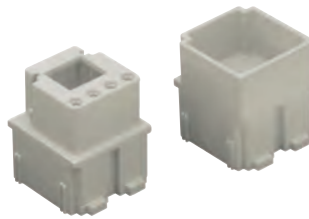

RJ45 connectors



description	part No.	part No. data contacts only	part No. data contacts/+2 power contacts
-------------	----------	--------------------------------	---

without RJ45 connector and without contacts (to be ordered separately)

- female inserts for 1 RJ45 female connector and for 4 10A (CDF) female contacts ¹⁾
- male inserts for 1 RJ45 male connector and for 4 10A (CDM) male contacts

CX 01 JF

CX 01 JM

RJ45 coupler jack, 8 data contacts ²⁾

RJ45 coupler jack, 8 data contacts / 2 power contacts ²⁾

CX 8 JF

CX 8/2 JF

RJ45 plug, 4 data contacts

RJ45 plug, 4 data contacts / 2 power contacts

RJ45 plug, 6 data contacts / 2 power contacts

RJ45 plug, 8 data contacts **Cat. 5e**

RJ45 plug, 4 data contacts **Cat. 5e ProfINET®**

CX 4 JM

CX 4/2 JM

CX 6/2 JM

CX 8 JM

CX 4E JM

RJ45 connector features:

- RJ45 insert, **Cat. 5 Ethernet**
- rated current: 2,1A at 70 °C
- rated voltage: 50VDC / 35VAC
- IDC terminals:
 - for 0,22 mm² (AWG 24/7) data contacts **CX 4 JM**
 - for 0,14 mm² (AWG 26/7) or 0,22 mm² (AWG 24/7) data contacts **CX 4/2 JM**
 - for 0,34 mm² (AWG 22/7) or 0,38 mm² (AWG 22/19) power contacts **CX 4/2 JM**
 - for 0,14 mm² (AWG 26/7) data contacts **CX 6/2 JM**
 - for 0,25 mm² (AWG 23/19) power contacts **CX 6/2 JM**
 - for 0,14 mm² (AWG 26/7) data contacts **CX 8 JM**
 - for 0,34 mm² (AWG 22/7) data contacts **CX 4E JM**
- /7 = 7-strands wire
- /19 = 19-strands wire
- insulation diameter: 1 mm (data), 1,4 mm (power and CX 4E JM)
- \varnothing_{max} complete cable 7 mm (CX 8 JM: 6,9 mm)
- temperature range: from -40°C to 120 °C
- nickel plated brass screening
- crimp pliers: **CJPZ Y**
- screened cable stripper: **CJST**

¹⁾ **WARNING:**

the female inserts can only be used on high or flush mounting enclosures

CX 01 JF, CX 01 JM

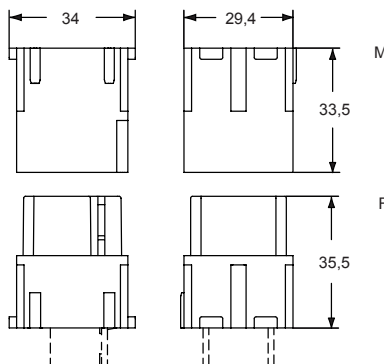

contacts side (front view)

side with reference arrow ▲

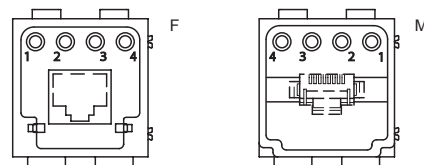

- 2 frame slots

²⁾ 4-pole version on request, part No. **CX 4 JF** and **CX 4/2 JF** with "crossover" link

CX 4 JF, CX 4/2 JF, CX 8 JF, CX 8/2 JF

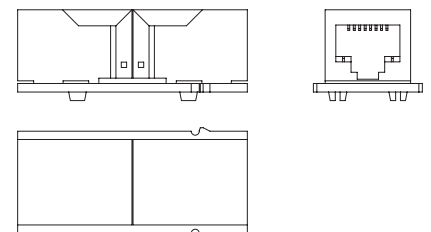

CX 4 JM, CX 4/2 JM, CX 6/2 JM, CX 8 JM, CX 4E JM

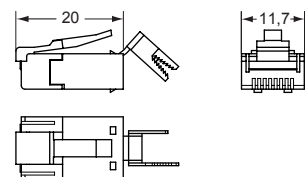

MIXO DATA

CW patch cord RJ45

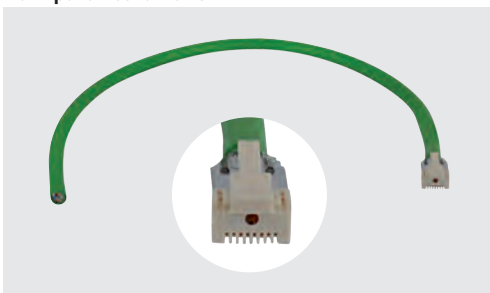

CW JM from page 308

10A crimp contacts, silver and gold plated



description	part No.	part No.
10A female crimp contacts		
0,14-0,37 mm ² AWG 26-22 identification No. 1	CDFA 0.3	CDFD 0.3
0,5 mm ² AWG 20 identification No. 2	CDFA 0.5	CDFD 0.5
0,75 mm ² AWG 18 identification No. ②	CDFA 0.7	CDFD 0.7
1 mm ² AWG 18 identification No. 3	CDFA 1.0	CDFD 1.0
1,5 mm ² AWG 16 identification No. 4	CDFA 1.5	CDFD 1.5
2,5 mm ² AWG 14 identification No. 5	CDFA 2.5	CDFD 2.5
	silver plated	gold plated+
10A male crimp contacts		
0,14-0,37 mm ² AWG 26-22 identification No. 1	CDMA 0.3	CDMD 0.3
0,5 mm ² AWG 20 identification No. 2	CDMA 0.5	CDMD 0.5
0,75 mm ² AWG 18 identification No. ②	CDMA 0.7	CDMD 0.7
1 mm ² AWG 18 identification No. 3	CDMA 1.0	CDMD 1.0
1,5 mm ² AWG 16 identification No. 4	CDMA 1.5	CDMD 1.5
2,5 mm ² AWG 14 identification No. 5	CDMA 2.5	CDMD 2.5

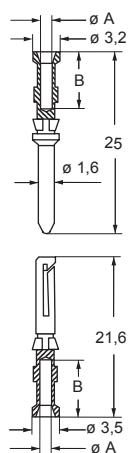

CDF and CDM contacts

conductor section (mm ²)	conductor slot $\varnothing A$ (mm)	conductors stripping length B (mm)
0,14-0,37	0,9	8
0,5	1,1	8
0,75	1,3	8
1,0	1,45	8
1,5	1,8	8
2,5	2,2	6





+ for basic or high thickness gold plating, please refer to page 674

for 2 RJ45 + 8 poles connector 10A - 250V

The modular inserts must be installed in suitable frames, which are then mounted in traditional enclosures or in COB panel supports.

page: 316

frames for modular units

- characteristics according to EN 61984: **10A 250V 4kV 3**
- cULus (UL for USA and Canada),   
-  **ERIC** certified
- insulation resistance: $\geq 10 \text{ G}\Omega$
- made of self-extinguishing thermoplastic resin UL 94V-0
- mechanical life: ≥ 500 cycles
- contact resistance: $\leq 3 \text{ m}\Omega$
- **it is recommended to crimp the contacts with crimping tools homologated by ILME** (please see the crimping tool section 10A contacts, CDF and CDM series) on pages 708 - 741

housing for RJ45 + 8 poles connector



RJ45 connectors



description	part No.	part No. data contacts only	part No. data contacts/+2 power contacts
-------------	----------	-----------------------------	--

without RJ45 connector and without contacts (to be ordered separately)

- female insert for 2 RJ45 female connectors and for 8 10A (CDF) female contacts ¹⁾
- male insert for 2 RJ45 male connectors and for 8 10A (CDM) male contacts

RJ45 coupler jack, 8 data contacts ²⁾	CX 02 JF		
RJ45 coupler jack, 8 data contacts / 2 power contacts ²⁾	CX 02 JM		

RJ45 plug, 4 data contacts		CX 8 JF	
RJ45 plug, 4 data contacts / 2 power contacts		CX 4 JM	CX 8/2 JF
RJ45 plug, 6 data contacts / 2 power contacts			CX 4/2 JM
RJ45 plug, 8 data contacts Cat. 5e			CX 6/2 JM
RJ45 plug, 4 data contacts Cat. 5e ProfINET®		CX 8 JM	
		CX 4E JM	

RJ45 connector features:

- RJ45 insert, **Cat. 5 Ethernet**
- rated current: 2,1A at 70 °C
- rated voltage: 50VDC / 35VAC
- IDC terminals:
- for 0,22 mm² (AWG 24/7) data contacts **CX 4 JM**
- for 0,14 mm² (AWG 26/7) or 0,22 mm² (AWG 24/7) data contacts **CX 4/2 JM**
- for 0,34 mm² (AWG 22/7) or 0,38 mm² (AWG 22/19) power contacts **CX 4/2 JM**
- for 0,14 mm² (AWG 26/7) data contacts **CX 6/2 JM**
- for 0,25 mm² (AWG 23/19) power contacts **CX 6/2 JM**
- for 0,14 mm² (AWG 26/7) data contacts **CX 8 JM**
- for 0,34 mm² (AWG 22/7) data contacts **CX 4E JM**
- /7 = 7-strands wire
- /19 = 19-strands wire
- insulation diameter: 1 mm (data), 1,4 mm (power and CX 4E JM)
- \varnothing_{max} complete cable 7 mm (CX 8 JM: 6,9 mm)
- temperature range: from -40°C to 120 °C
- nickel plated brass screening
- crimp pliers: **CJPZ Y**
- screened cable stripper: **CJST**

¹⁾ **WARNING:**

the female inserts can only be used on high or flush mounting enclosures

CX 02 JF, CX 02 JM

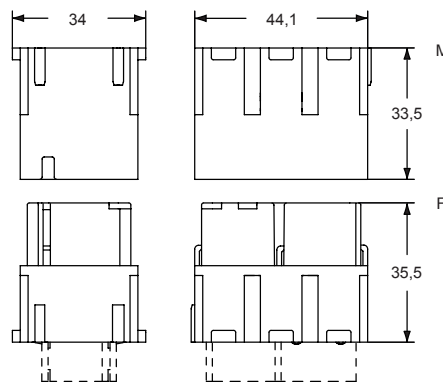

contacts side (front view)

side with reference arrow ▲

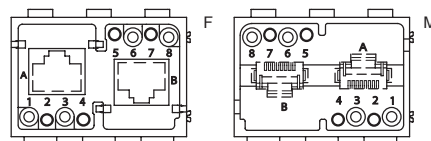

- 3 frame slots

²⁾ 4-pole version on request, part No. **CX 4 JF** and **CX 4/2 JF** with "crossover" link

CX 4 JF, CX 4/2 JF, CX 8 JF, CX 8/2 JF

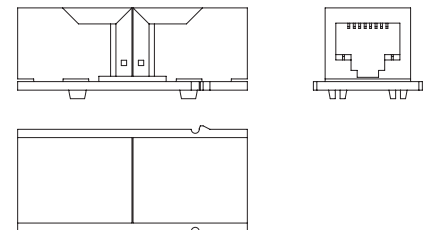

CX 4 JM, CX 4/2 JM, CX 6/2 JM, CX 8 JM, CX 4E JM

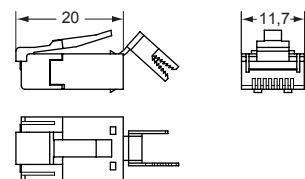

CW patch cord RJ45

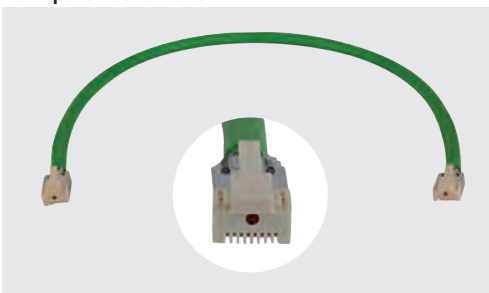

CW J2M from page 308

10A crimp contacts, silver and gold plated



description	part No.	part No.
10A female crimp contacts		
0,14-0,37 mm ² AWG 26-22 identification No. 1	CDFA 0.3	CDFD 0.3
0,5 mm ² AWG 20 identification No. 2	CDFA 0.5	CDFD 0.5
0,75 mm ² AWG 18 identification No. ②	CDFA 0.7	CDFD 0.7
1 mm ² AWG 18 identification No. 3	CDFA 1.0	CDFD 1.0
1,5 mm ² AWG 16 identification No. 4	CDFA 1.5	CDFD 1.5
2,5 mm ² AWG 14 identification No. 5	CDFA 2.5	CDFD 2.5
	silver plated	gold plated+
10A male crimp contacts		
0,14-0,37 mm ² AWG 26-22 identification No. 1	CDMA 0.3	CDMD 0.3
0,5 mm ² AWG 20 identification No. 2	CDMA 0.5	CDMD 0.5
0,75 mm ² AWG 18 identification No. ②	CDMA 0.7	CDMD 0.7
1 mm ² AWG 18 identification No. 3	CDMA 1.0	CDMD 1.0
1,5 mm ² AWG 16 identification No. 4	CDMA 1.5	CDMD 1.5
2,5 mm ² AWG 14 identification No. 5	CDMA 2.5	CDMD 2.5

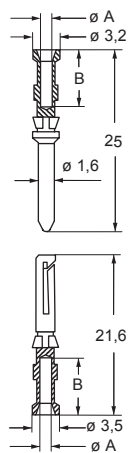

CDF and CDM contacts

conductor section (mm ²)	conductor slot $\varnothing A$ (mm)	conductors stripping length B (mm)
0,14-0,37	0,9	8
0,5	1,1	8
0,75	1,3	8
1,0	1,45	8
1,5	1,8	8
2,5	2,2	6

+ for basic or high thickness gold plating, please refer to page 674

CW patch cord RJ45

with 1 RJ45 male connector

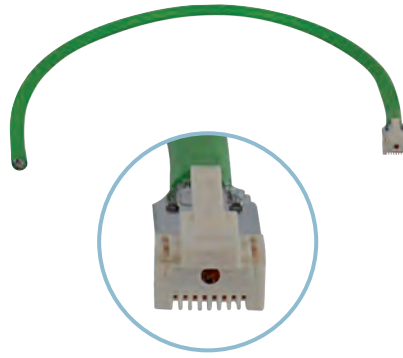

with 2 RJ45 male connectors

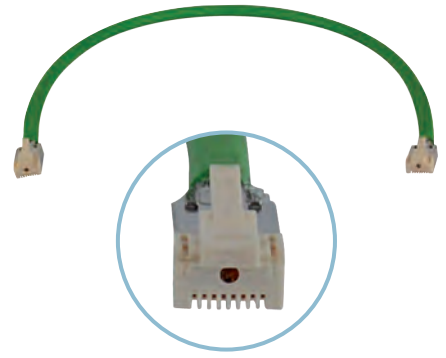

description	part No.	(L) metre	part No.	(L) metre
RJ45 male connector with 4 data contacts / 2 power contacts	CW 0.5 JM4/2	0.5		
	CW 2 JM4/2	2		
	CW 5 JM4/2	5		
	CW 10 JM4/2	10		
RJ45 male connector with 8 data contacts	CW 0.5 JM8	0.5	CW 0.5 J2M8	0.5
	CW 2 JM8	2	CW 2 J2M8	2
	CW 5 JM8	5	CW 5 J2M8	5
	CW 10 JM8	10	CW 10 J2M8	10
RJ45 male connector with 4 data contacts, Cat. 5e	CW 0.5 JM4E	0.5	CW 0.5 J2M4E	0.5
	CW 2 JM4E	2	CW 2 J2M4E	2
	CW 5 JM4E	5	CW 5 J2M4E	5
	CW 10 JM4E	10	CW 10 J2M4E	10

RJ45 connector features:

- insert RJ45, Cat. 5 Ethernet
- nominal current: 2,1A at 70 °C
- nominal voltage: 50V DC / 35V AC
- temperature range: from -40 °C to +120 °C
- nickel plated brass screening

Can be used with:

- MIXO RJ45: CX 01 JM and CX 02 JM male inserts
see pages 304 and 306

CW JM 4/2, 8, 4E and CW J2M 4/2, 8, 4E

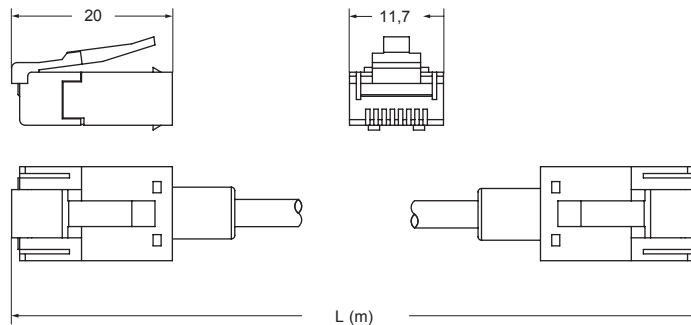

Wiring Diagram

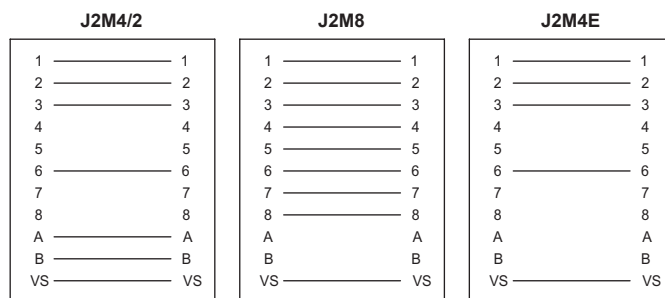

MIXO DATA

CX FM

The modular inserts must be installed in suitable frames, which are then mounted in traditional enclosures or in COB panel supports.
 Alternatively, individual modules with a width of 14,7 mm can be installed in plastic supports.

frames for modular units

page:
316

dummy module



description	part No.
-------------	----------

dummy module for unused frame seats

CX FM

Remark:
 The new version is formed by a single piece and has a reduced height.
 It allows the mating of a MIXO insert including it with a corresponding MIXO insert even having - in front of the dummy module - a regular male or female module equipped with contacts, which obviously will not work.
 The sole exceptions to this feature are that an insert with this dummy module cannot mate an insert showing in front a CX 3/4 XDF/M, CX 04 XF/M or CX 02 HF module.

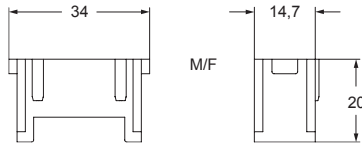

- 1 frame slot

MIXO INSERTS

MIXO units

MIXO a-f frame for housings

Enclosures

RJ45 MIXO CONNECTOR Cat 6^A

RJ45 female/female coupler



CX 01 J8F

RJ45 MIXO CONNECTOR Cat 5-5e

1x RJ45 female/female coupler
+ 4x 10A crimp contacts

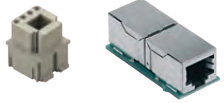

CX 01 JF+ CX 8 JF
or
CX 8/2 JF

2x RJ45 female/female coupler
+ 8x 10A crimp contacts



CX 02 JF + 2x CX 8 JF
or
2x CX 8/2 JF

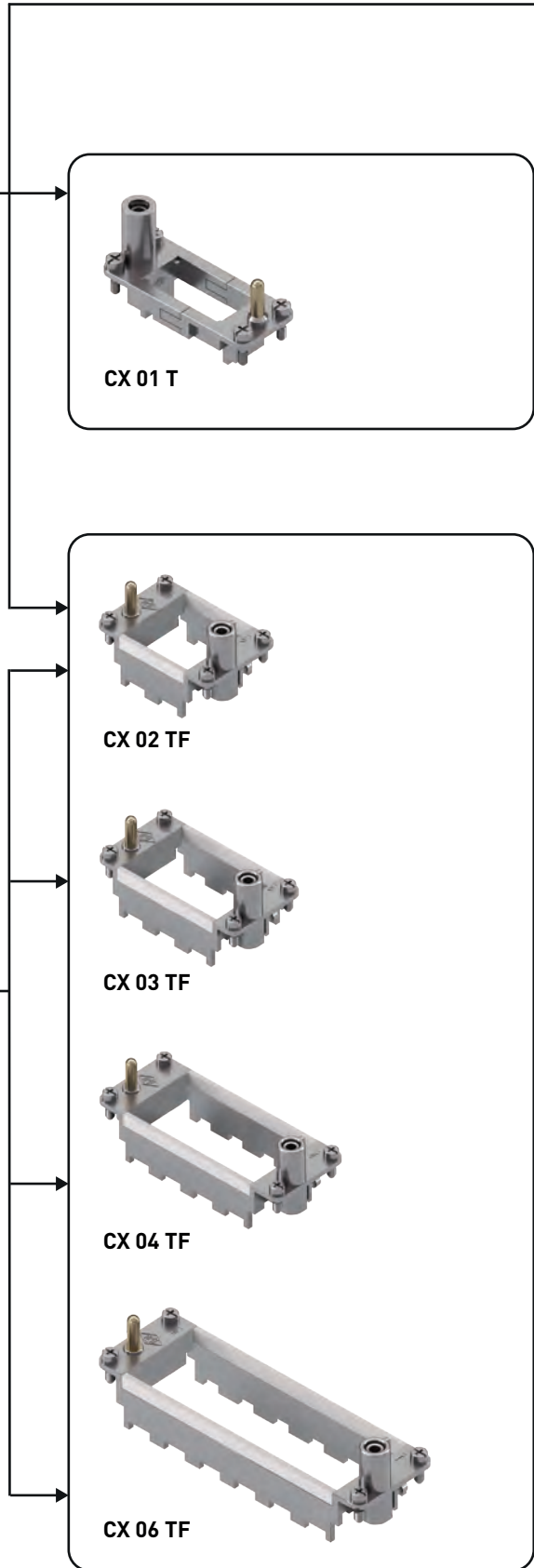

MIXO ONE

CZ IL-BRID

C-TYPE

C7 IP68

V-TYPE

T-TYPE

W-TYPE

EMC

LS-TYPE

COB

IP68

Central lever

BIG

MIXO RJ45

Enclosures

MIXO A-F frame for hoods

MIXO units

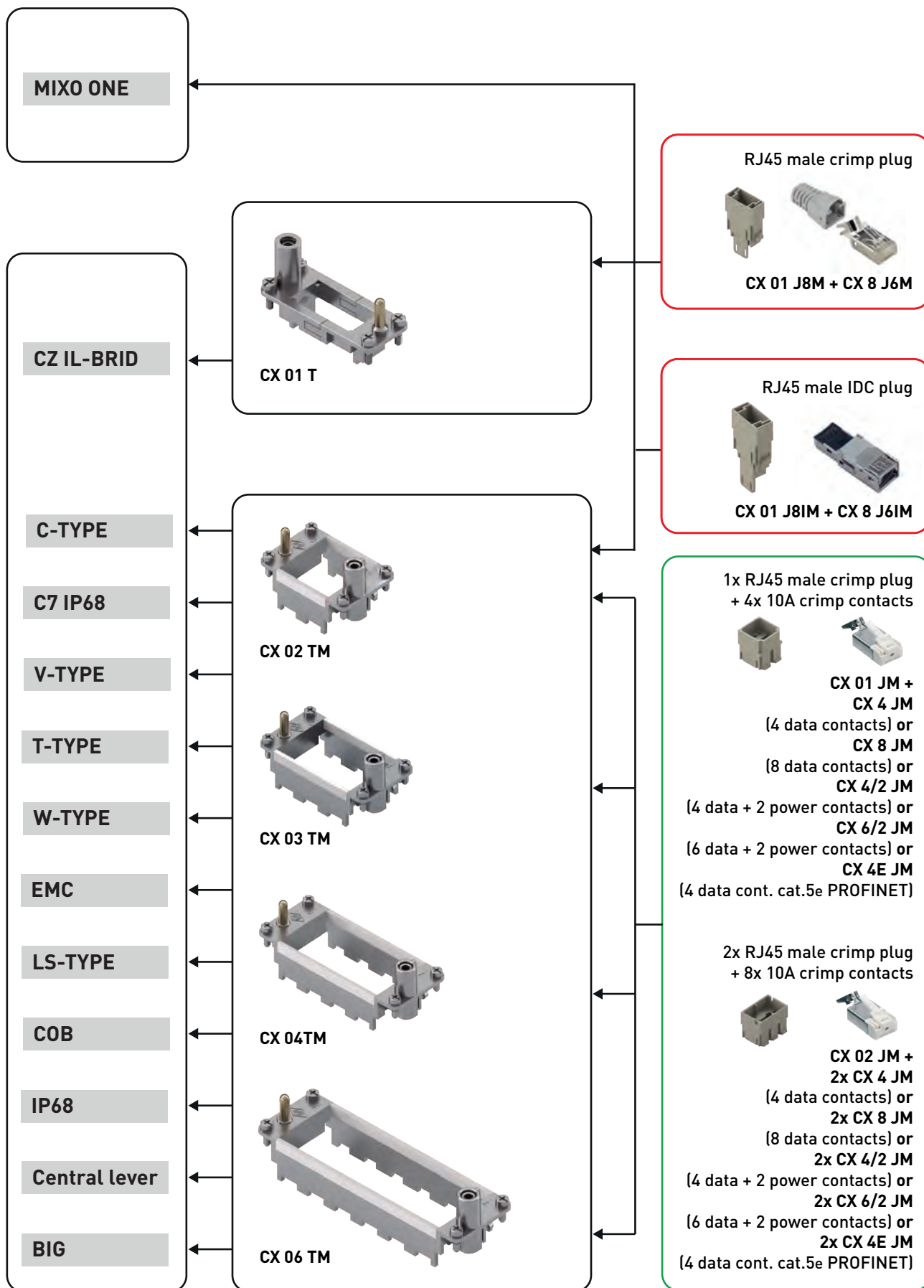

RJ45 MIXO CONNECTOR Cat 5-5e

RJ45 MIXO CONNECTOR Cat 6

MIXO RJ45

CX 03 P - CX 02 P for pneumatic contacts

The modular inserts must be installed in suitable frames which are then mounted in traditional enclosures or in COB panel support.
Single-sized modular units may be directly mounted inside MIXO ONE enclosures.

	page:
frames for modular units	316 - 317
MIXO ONE enclosures	369

modular units with 3 seats

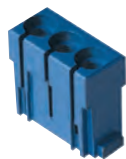

modular units with 2 seats



description

part No.

part No.

without contacts (to be ordered separately)
inserts with 3 housings for tube Ø 1,6 - 4,0

CX 03 P

without contacts (to be ordered separately)
inserts with 2 housings for tube Ø 6,0

CX 02 P

- certified
- insulation resistance: $\geq 10 \text{ G}\Omega$
- made of self-extinguishing thermoplastic resin UL 94V-0
- mechanical life: ≥ 500 cycles

Use of units for pneumatic contacts

- identical male and female modular units
- pneumatic contacts for pressure values up to 8 bar, for use with clean and dry compressed air
- use of tubes with Ø 1,6 - 3 - 4 and 6 mm, and possible replacement of tubes with assembled units
- possibility of using tubes with different diameters in the same modular unit
- female contacts with or without closing valve
- working temperature range - 40 °C + + 80 °C

Warnings:

CRM/F CX code pins and guides must be used for pneumatic contacts modules.
These pins also provide coding if pneumatic contacts modules are used exclusively.

The use of pneumatic contacts requires an appropriate filtering and dehydration system to prevent dangerous condensation.
Contacts may be used for pressure values of up to a maximum of 8 bars/116 psi.

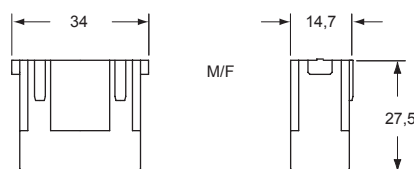

contacts side (front view)

side with reference arrow ▲

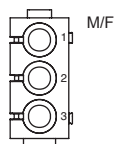

- 1 frame slot

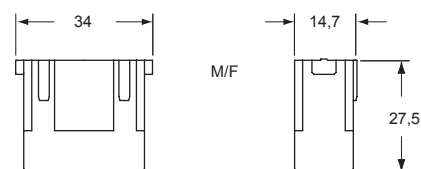

contacts side (front view)

side with reference arrow ▲

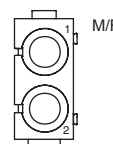

- 1 frame slot

**pneumatic contacts
with or without closing valve**



description	part No.
female contacts without closing valve - for tubes with internal \varnothing 1,6 mm - for tubes with internal \varnothing 3 mm - for tubes with internal \varnothing 4 mm - for tubes with internal \varnothing 6 mm	CX 1.6 PF CX 3.0 PF CX 4.0 PF CX 6.0 PF
male contacts without closing valve - for tubes with internal \varnothing 1,6 mm - for tubes with internal \varnothing 3 mm - for tubes with internal \varnothing 4 mm - for tubes with internal \varnothing 6 mm	CX 1.6 PM CX 3.0 PM CX 4.0 PM CX 6.0 PM
female contacts with closing valve - for tubes with internal \varnothing 1,6 mm - for tubes with internal \varnothing 3 mm - for tubes with internal \varnothing 4 mm - for tubes with internal \varnothing 6 mm	CX 1.6 VC CX 3.0 VC CX 4.0 VC CX 6.0 VC
male contact (use contacts without closing valve)	

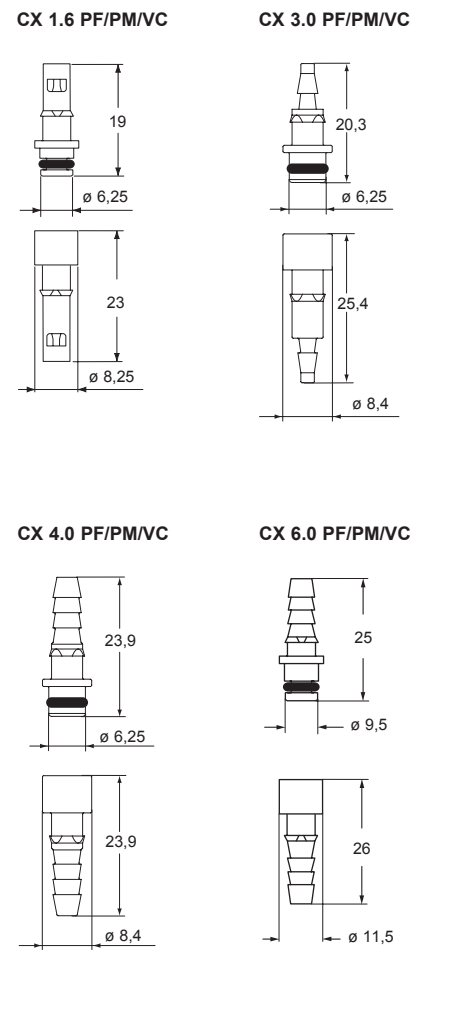

MIXO FRAMES

Made of die-cast zinc alloy
with protective earth (PE) contacts

SUM UP

- ❑ Die-cast zinc alloy frames
- ❑ Protective earth (PE)
- ❑ Possibility of mounting female and male modular units on the same frame
- ❑ Polarisation on frames
- ❑ When two or more identical connectors of the MIXO series are used, use of coding pins (CR...CX series) may prevent incorrect coupling

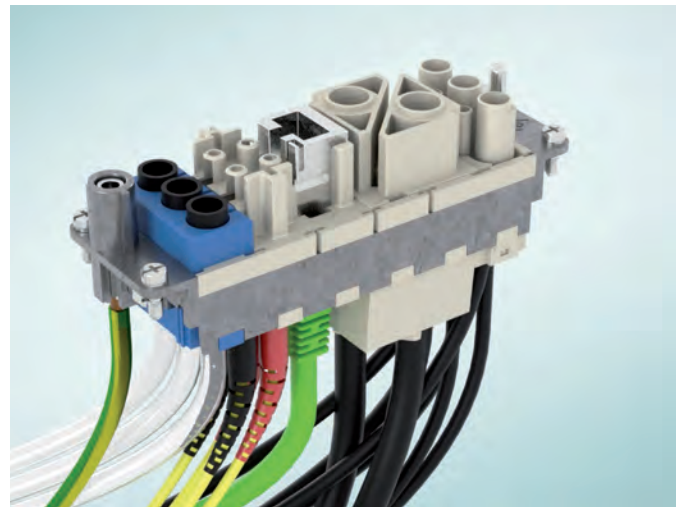

TECHNICAL FEATURES

MIXO FRAMES

HOW TO SELECT FRAMES

- 1 **Calculate** the number of frame slots taken up by the required inserts (frame slot 1, 2 or 3 modules).



	No. of frame slots
CX 01 9VF/M	1
CX 01 9VTF	1
CX 01 GF/M	1
CX 01 J8	1
CX 01 UF/M	1
CX 02 4AF/M	1
CX 02 4BF/M	1
CX 02 4F/M	1
CX 02 7F/M	1
CX 02 CHF/M	1
CX 02 P	1
CX 03 4F/M	1
CX 03 4BF/M	1
CX 03 P	1
CX 3/4 XDF/M	1
CX 04 LF/M	1
CX 04 RF/M	1
CX 04 SCF/M	1
CX 04 XF/M	1
CX 05 SF/M	1
CX 05 SHF/M	1
CX 06 CF/M	1
CX 06P CF/M	1
CX 08 CF/M	1
CX 08 I6F/M	1
CX 12 DF/M	1
CX 17 DF/M	1
CX 25 IBF/M	1
CX 25 IF/M	1
CX FM	1



	No. of frame slots
CX 01 JF/M	2
CX 01 YF/M	2
CX 01 YPEF/M	2
CX 02 BF/M	2
CX 02 GF/M	2
CX 02 HF/M	2
CX 20 CF/M	2
CX 42 DF/M	2

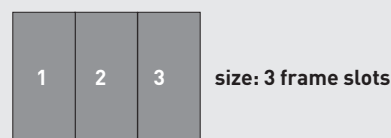

	No. of frame slots
CX 02 JF/M	3

- 2 **Select** the right frame according to the number of required modules (available 1, 2, 3, 4 and 6 modules).

CX 01 T
1 module



CX 02 TF/TM
2 modules



CX 03 TF/TM
3 modules



CX 04 TF/TM
4 modules



CX 06 TF/TM
6 modules

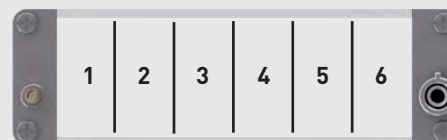

- Fill the unused frame slots with CX FM dummy module



Possibility to use the MIXO **HNM frames** (provided with special gold plated PE contacts) together with R series of crimp contacts and the relevant connector hoods and housings, to produce where

required an **HNM** connector (High Number of Matings, up to 10.000 cycles of operation).

CX 01 T

enclosures: size "49.16"	page:
IL-BRID	374 - 377, 382
CZ7 IP67, single lever	384
W-TYPE for aggressive environments	519
E-Xtreme® corrosion proof	540
EMC	576
panel supports:	page:
COB + adaptor	652 - 654

frames for modular units



description

part No.

for CZ enclosures

CX 01 T

- die-cast zinc alloy frames
- protective earth (PE)
- coding pins **CR..CX**

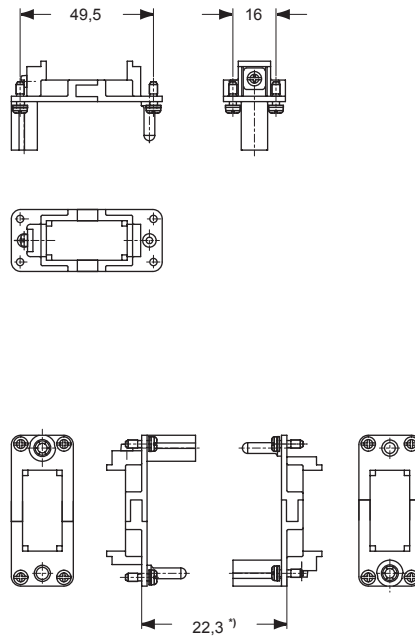

*) distance for electric contacts: max 24 mm
distance for pneumatic contacts: max 23,5 mm

- small earth terminal for cables from 1-2,5 mm²,
AWG 18-14

CX 02 TM/TF, CX 03 TM/TF, CX 04 TM/TF, CX 06 TM/TF

enclosures:	page:
C-TYPE IP65 or IP66/IP69	387 - 430
C7 IP67	436 - 442
V-TYPE IP65 or IP66/IP69	444 - 463
BIG hoods	466 - 473
T-TYPE IP65 insulating	480 - 487
T-TYPE / W IP66/IP69 insulating	489 - 492
HYGIENIC T-TYPE / H IP66/IP69	501 - 504
HYGIENIC T-TYPE / C IP66/IP69, -50 °C	506 - 509
W-TYPE for aggressive environments	521 - 526
E-Xtreme® corrosion proof	530 - 537
	542 - 547
	550 - 557
EMC	578 - 581
Central lever	603 - 614
LS-TYPE	618 - 625
IP68	632 - 647
panel supports:	page:
COB	652 - 653

frames for modular units with lock-in tab (included)

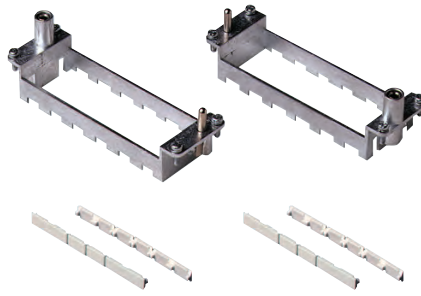

description	part No.	part No.
frames for modular units, with lock-in tab included	type for hoods*	type for housings*
for 2 modular units - for housing size 44.27	CX 02 TM	CX 02 TF
for 3 modular units - for housing size 57.27	CX 03 TM	CX 03 TF
for 4 modular units - for housing size 77.27 and 77.62	CX 04 TM	CX 04 TF
for 6 modular units - for housing size 104.27 and 104.62	CX 06 TM	CX 06 TF

- die-cast zinc alloy frames
- protective earth (PE)
- possibility of mounting female and male modular units on the same frame
- frames supplied with lock-in tab to attach units
- polarisation on frames
- coding pins **CR..CX**
- for spare lock-in tab **CX CFM** see SPARE SPARTS catalogue

* Assignment of attribute "for hoods" or "for housings" is merely conventional: both types can be mounted either in a hood or in a housing. In a modular connector coupling there shall be always a frame type "M" and a frame type "F".

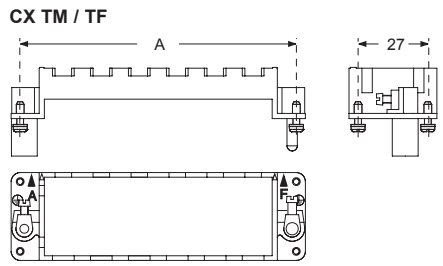

part No.	A (mm)	for housings size
CX 02 TM / TF	44	44.27
CX 03 TM / TF	57	57.27
CX 04 TM / TF	77,5	77.27 and 77.62
CX 06 TM / TF	104	104.27 and 104.62

Earth terminal
 - large: for cables from 4-6 mm², AWG 12-10
 - small: for cables from 1-2,5 mm², AWG 18-14

In order to accommodate larger PE conductor cross-sectional area, use CGT PE adapters, see page 319.

position of modules (contact side view)

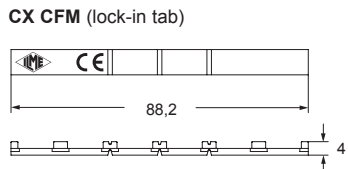
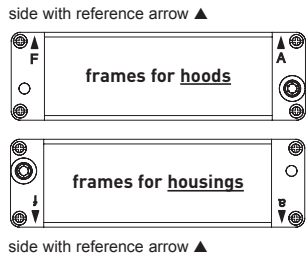

Polarisation of frames with relative identification letters and couplings

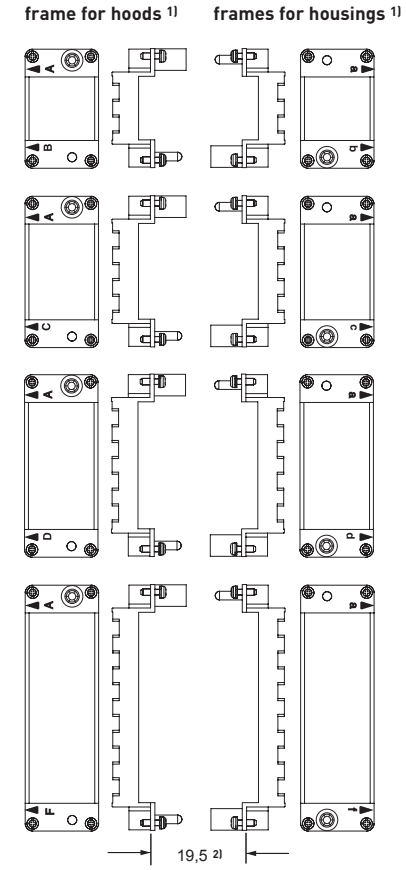

- 1) Warning:**
 The module support frames are marked:
 - FOR HOODS: **upper-case A-B, A-C, A-D and A-F**
 - FOR HOUSINGS: **lower-case a-b, a-c, a-d and a-f**
- Positioning the modules in the frames according to the respective letters is ensuring the specular assembly of modules, for which the hood will be coupled correctly to the housing.
- 2) Distance for:**
 - electric and fibre optic contacts: max 21 mm
 - pneumatic contacts: max 20,5 mm

MIXO INSERTS

CGT 6.0 – CGT 10 – CGT 16 – CGT 25

PE terminal adapters for MIXO frames

- **PE terminal adapter CGT 6.0** made of nickel plated brass that allows to connect by crimping a 6 mm² / 10 AWG flexible copper conductor **to the small PE terminal** (2,5 mm² / 14 AWG) of a MIXO frame, in case the connector needs a second PE line sized 6 mm²/10 AWG when the large PE terminal (6 mm²/10 AWG) of the MIXO frame is already occupied by a large size PE conductor, by using the existing PE terminal adapter **CGT 16**, or the new ones for the large PE terminal, **CGT 10 or CGT 25**.

- **PE terminal adapters CGT 10 and CGT 25** made of nickel plated brass that allow to connect by crimping respectively a 10 mm² / 8 AWG or a 25 mm² / 4 AWG flexible copper conductor **to the large PE terminal** (6 mm²/10 AWG) of a MIXO frame.

- They are offered in addition to the existing PE terminal adapter **CGT 16** for 16 mm² / 6 AWG protective earth conductor – introduced with MIXO 100A modules **CX 02 G and CX 01 G** – to give more flexibility for the combination of MIXO 100A and 70A high power modules with **multi-core cables**, that have the PE conductor of the same size of the phase conductors.

- Crimping is achieved by using the already available manual hydraulic crimping tool **CPPZ C** (Cembre HT 45) with hexagonal crimping dies **CGD 10 C** (for **CGT 10** with 10 mm² / 8 AWG and for **CGT 6.0** with 6 mm² / 10 AWG flexible copper conductors) and **CGD 25 C** (for **CGT 25** with 25 mm² / 4 AWG flexible copper conductors).

CGT 6.0



CGT 10



CGT 16

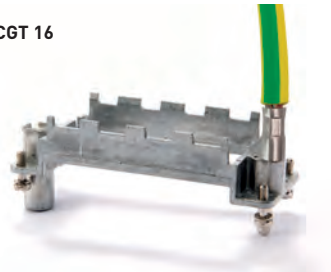

CGT 25

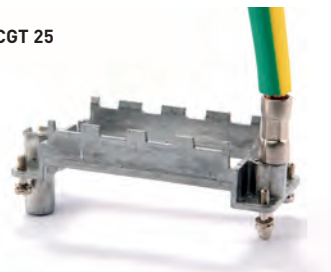

CGT 6.0 - CGT 10 - CGT 16 - CGT 25

The modular inserts must be installed in suitable frames, which are then mounted in traditional enclosures or in COB panel supports.

frames for modular units page:
316 - 317

Cannot be used in surface mounting housings or low construction hoods.

Cannot be used with T-TYPE surface mounting housings and horizontal cable outlet hoods.

PE terminal adapter

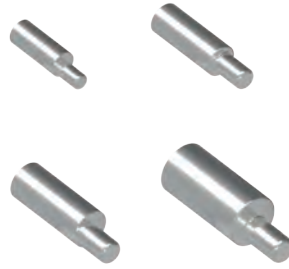

headless screw M4X6



description	part No.	part No.
-------------	----------	----------

PE wire terminal adapter 6 mm ² (10 AWG)	CGT 6.0
PE wire terminal adapter 10 mm ² (8 AWG)	CGT 10
PE wire terminal adapter 16 mm ² (6 AWG)	CGT 16
PE wire terminal adapter 25 mm ² (4 AWG)	CGT 25

headless screw M4X6, stainless steel, kit of 10 pcs. ¹⁾	CR VGM4
--	----------------

¹⁾ For the use with T-TYPE bulkhead housings and vertical entry hoods it is needed to replace the M4 screw of the 6 mm² PE contact of the frame with the headless screw **CR VGM4**.

How to use the PE terminal adapter

- 1) Strip 15 mm of flexible PE wire.
- 2) Crimp the cable on the CGT adapter by using the CPPZ C pliers with the dies as follows:
 - **CGD 10 C** for 6 mm² and 10 mm²
 - **CGD 16 C** for 16 mm²
 - **CGD 25 C** for 25 mm²
- 3) Fix the adapter tip in the larger earth terminal (6 mm²) for CGT 10, CGT 16, CGT 25 or in the smaller earth terminal (2,5 mm²) for CGT 6.0 of frames CX...TM/TF.

CGT 6.0

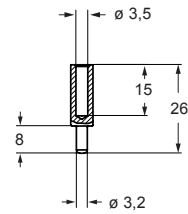

CGT 10

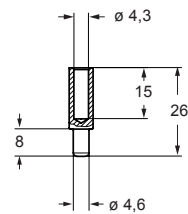

CGT 16

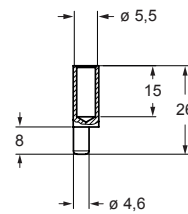

CGT 25

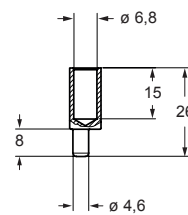

cURus pending

MIXO INSERTS

MODULES FOR HIGH NUMBER OF MATINGS

Within the range of **series HNM**, for High Number of Matings, all MIXO modules for crimp contacts 40 A, 16 A and/or 10 A, combined with the use of especially high thickness gold-plated/lubricated crimp contacts of:

- series **RX** (40 A HNM variant of series CX),
- series **RC** (16 A HNM variant of series CC), and
- series **RD** (10 A HNM variant of series CD)

mounted in the dedicated **MIXO HNM frames** cat. nos. **RX 02 /03 /04 /06 TF /TM**, also employing especially gold-plated PE contacts, allow the creation of **HNM** modular connector inserts.

The connector modules of series MIXO that by using HNM 40 A contacts series **RX**, HNM 16 A contacts series **RC** and/or HNM 10 A contacts series **RD** together with **MIXO HNM frames** RX 02...06 TF/M can create MIXO HNM modular connector inserts are:

- **CX 02 4F/M, CX 03 4F/M, CX 03 4BF/M** and **CX 04 XF/XM** (with **RX** HNM contacts)
- **CX 3/4 XDF/M** (with **RX** and **RD** HNM contacts)
- **CX 06 CF/M, CX 06P CF/M, CX 08 CF/M** and **CX 20 CF/M** (with **RC** HNM contacts)
- **CX 12 DF/M, CX 17 DF/M** and **CX 42 DF/M** (with **RD** HNM contacts)

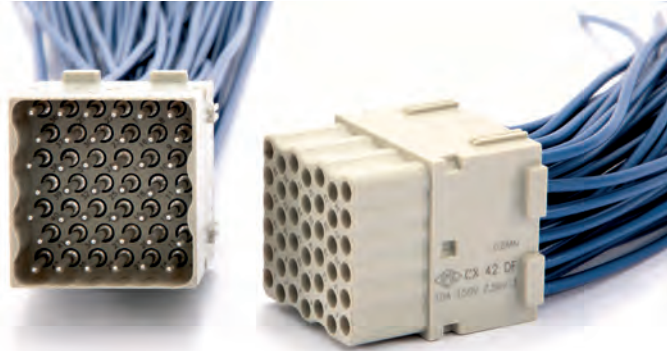

SUM UP

- ☑ Up to 10.000 matings in combination with HNM enclosures
- ☑ Up to 5.000 matings with standard hoods with single lever

Q NOTE

For contacts in **HNM** version (series **RI, RD, RC** and **RX**) the same tools are suitable for crimping, insertion/extraction (where indicated), as those used for the corresponding contacts in standard version (respectively series **CI, CD, CC** and **CX**).



The modular inserts must be installed in suitable frames, which are then mounted in traditional enclosures* or in COB panel supports.

frames for modular units*

page: 333

* enclosures: bulkhead mounting housings, high construction housings or high construction hoods

modular units, crimp connections

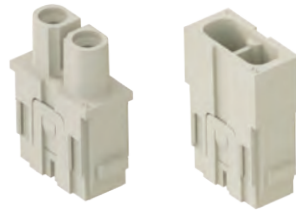

Q 10.000 MATINGS WITH HNM FRAMES AND HNM ENCLOSURES

Q 5.000 MATINGS WITH HNM FRAMES AND STANDARD ENCLOSURES, SINGLE LEVER

40A crimp contacts gold plated



description	part No.	part No.
-------------	----------	----------

without contacts (to be ordered separately)
female inserts for female contacts ¹⁾
male inserts for male contacts ¹⁾

CX 02 4F
CX 02 4M

40A female crimp contacts
1,5 mm² AWG 16
2,5 mm² AWG 14
4 mm² AWG 12
6 mm² AWG 10
10 mm² AWG 8

RXF2D 1.5
RXF2D 2.5
RXF2D 4.0
RXF2D 6.0
RXF2D 10

gold plated

40A male crimp contacts
1,5 mm² AWG 16
2,5 mm² AWG 14
4 mm² AWG 12
6 mm² AWG 10
10 mm² AWG 8

RXM2D 1.5
RXM2D 2.5
RXM2D 4.0
RXM2D 6.0
RXM2D 10

¹⁾ cable diameter up to 7,5 mm
contact size up to 10 mm²

- characteristics according to EN 61984:
40A 1000V 8kV 3

- certified

- rated voltage according to UL/CSA: 600V

- insulation resistance: ≥ 10 GΩ

- ambient temperature limit: -40 °C ... +125 °C

- made of self-extinguishing thermoplastic resin
UL 94V-0

- mechanical life: ≥ 10.000 cycles

- contact resistance: ≤ 0,3 mΩ

- can be mated with CX 02 A/B modules

- **it is recommended to crimp the contacts**
(1,5 - 10 mm²), **with crimping tools homologated**
by ILME (please see the crimping tool section 40A
contacts, RXF2D and RXM2D series) on pages
708 - 741

- for max. current load see the connector inserts derating
diagram below; for more information see page 28

CX 02 4, 2 poles connector inserts
Maximum current load derating diagram

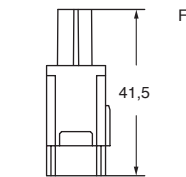
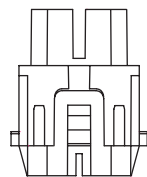
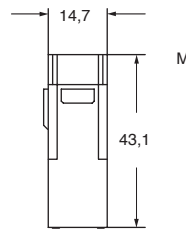
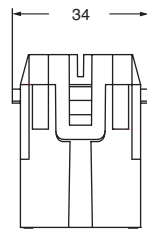
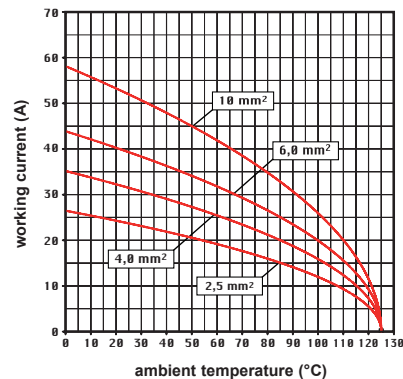

contacts side (front view)

side with reference arrow ▲

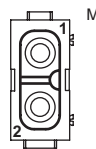

- 1 frame slot

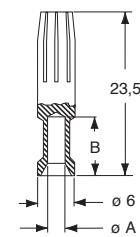
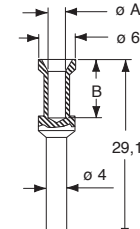

RXF2D and RXM2D contacts

conductor section (mm ²)	conductor slot ø A (mm)	conductor stripping length B (mm)
1,5	1,8	9
2,5	2,2	9
4	2,85	9,6
6	3,5	9,6
10	4,3	15

The modular inserts must be installed in suitable frames, which are then mounted in traditional enclosures or in COB panel supports.

frames for modular units

page: 333

modular units, crimp connections

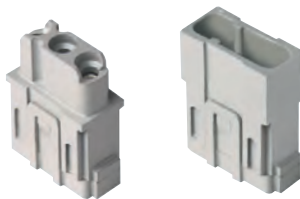

40A crimp contacts gold plated



Q 10.000 MATINGS WITH HNM FRAMES AND HNM ENCLOSURES

Q 5.000 MATINGS WITH HNM FRAMES AND STANDARD ENCLOSURES, SINGLE LEVER

description

part No.

part No

without contacts (to be ordered separately)

female inserts for female contacts ¹⁾

CX 03 4F

male inserts for male contacts ¹⁾

CX 03 4M

40A female crimp contacts

1,5 mm ²	AWG 16
2,5 mm ²	AWG 14
4 mm ²	AWG 12
6 mm ²	AWG 10

RXF2D 1.5
RXF2D 2.5
RXF2D 4.0
RXF2D 6.0

40A male crimp contacts

1,5 mm ²	AWG 16
2,5 mm ²	AWG 14
4 mm ²	AWG 12
6 mm ²	AWG 10

RXM2D 1.5
RXM2D 2.5
RXM2D 4.0
RXM2D 6.0

gold plated

¹⁾ cable diameter up to 5 mm

- characteristics according to EN 61984:

40A 400/690V 6kV 3

- cULus (UL for USA and Canada),

certified

- rated voltage according to UL/CSA: 600V

- insulation resistance: ≥ 10 GΩ

- ambient temperature limit: -40 °C ... +125 °C

- made of self-extinguishing thermoplastic resin UL 94V-0

- mechanical life: ≥ 10.000 cycles

- contact resistance: ≤ 0,3 mΩ

- it is recommended to crimp the contacts with crimping tools homologated by ILME (please see the crimping tool section 40A contacts, RXF2D and RXM2D series) on pages 708 - 741

- for max. current load see the connector inserts derating diagram below; for more information see page 28

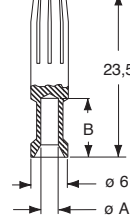
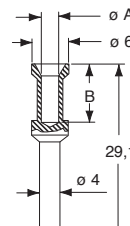
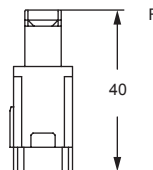
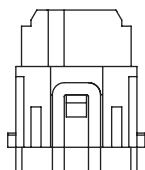
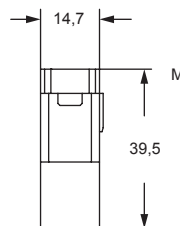
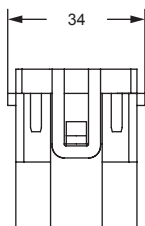

contacts side (front view)

side with reference arrow ▲

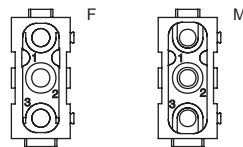

- 1 frame slot

RXF2D and RXM2D contacts

conductor section (mm ²)	conductor slot ø A (mm)	conductor stripping length B (mm)
1,5	1,8	9
2,5	2,2	9
4	2,85	9,6
6	3,5	9,6

CX 03 poles connector inserts Maximum current load derating diagram

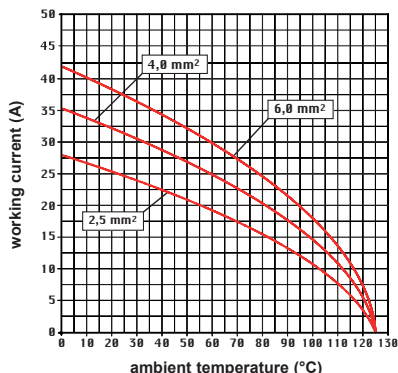



The modular inserts must be installed in suitable frames, which are then mounted in traditional enclosures* or in COB panel supports.

frames for modular units*

page: 333

* enclosures: bulkhead mounting housings, high construction housings or high construction hoods

modular units, crimp connections

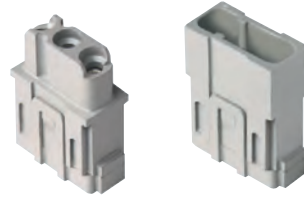

Q 10.000 MATINGS WITH HNM FRAMES AND HNM ENCLOSURES

Q 5.000 MATINGS WITH HNM FRAMES AND STANDARD ENCLOSURES, SINGLE LEVER

40A crimp contacts gold plated



description	part No.	part No.
-------------	----------	----------

without contacts (to be ordered separately)
female inserts for female contacts ¹⁾
male inserts for male contacts ¹⁾

CX 03 4BF
CX 03 4BM

40A female crimp contacts
1,5 mm² AWG 16
2,5 mm² AWG 14
4 mm² AWG 12
6 mm² AWG 10
10 mm² AWG 8

RXF2D 1.5
RXF2D 2.5
RXF2D 4.0
RXF2D 6.0
RXF2D 10

gold plated

40A male crimp contacts
1,5 mm² AWG 16
2,5 mm² AWG 14
4 mm² AWG 12
6 mm² AWG 10
10 mm² AWG 8

RXM2D 1.5
RXM2D 2.5
RXM2D 4.0
RXM2D 6.0
RXM2D 10

¹⁾ cable diameter up to 7,5 mm
contact size up to 10 mm²

- characteristics according to EN 61984:

40A 500V 6kV 3

- cULus (UL for USA and Canada), SB, CEC, DNV-GL

- BUREAU VERITAS ERI certified

- rated voltage according to UL/CSA: 600V

- insulation resistance: ≥ 10 GΩ

- ambient temperature limit: -40 °C ... +125 °C

- made of self-extinguishing thermoplastic resin
UL 94V-0

- mechanical life: ≥ 10.000 cycles

- contact resistance: ≤ 0,3 mΩ

- can be mated with CX 02 A/B modules

- **it is recommended to crimp the contacts**
(1,5 - 10 mm²), **with crimping tools homologated by ILME** (please see the crimping tool section 40A contacts, RXF2D and RXM2D series) on pages 708 - 741

- for max. current load see the connector inserts derating diagram below; for more information see page 28

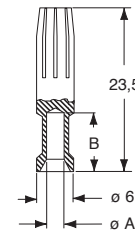
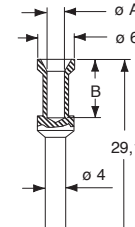
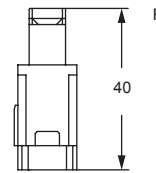
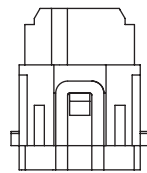
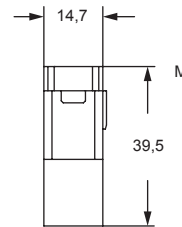
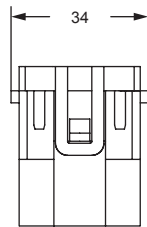

contacts side (front view)

side with reference arrow ▲

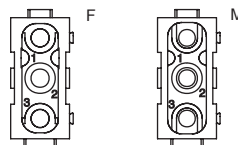

- 1 frame slot

CX 03 4B, 3 poles connector inserts
Maximum current load derating diagram

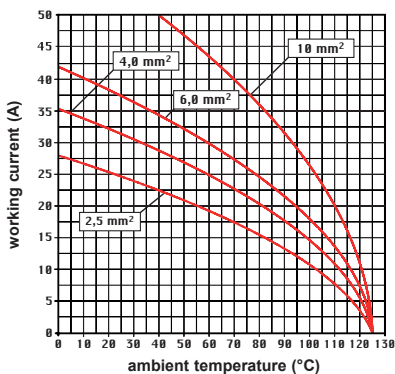

RXF2D and RXM2D contacts

conductor section (mm ²)	conductor slot ϕA (mm)	conductor stripping length B (mm)
1,5	1,8	9
2,5	2,2	9
4	2,85	9,6
6	3,5	9,6
10	4,3	15

The modular inserts must be installed in suitable frames, which are then mounted in traditional enclosures or in COB panel supports.

page:

frames for modular units

333

- male and female contacts finger proof
- their key characteristic lies in the fact that they guarantee maximum safety even in case of accidental contact with fingers (IP2X or IPXXB). Safety is guaranteed as standard on female contacts, but also on male contacts. This feature is important as it ensures full compliance with the recent safety standard EN 60204-1, concerning electric equipment fitted on machines and in particular with the requirements of Article 6.2.4 concerning protection against residual voltage. In the case of plugs or similar devices, the withdrawal of which results in the exposure of conductors (for example pins), the discharge time shall not exceed 1 s, otherwise such conductors shall be protected against direct contact to at least an IP2X or IPXXB.

modular units, crimp connections

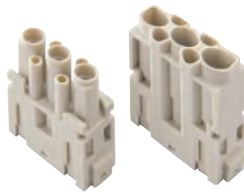

Q 10.000 MATINGS WITH HNM FRAMES AND HNM ENCLOSURES

Q 5.000 MATINGS WITH HNM FRAMES AND STANDARD ENCLOSURES, SINGLE LEVER

40A and 10A crimp contacts gold plated

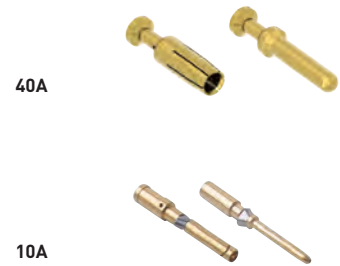

description

part No.

part No

without contacts (to be ordered separately)

female inserts for female contacts

CX 3/4 XDF

male inserts for male contacts

CX 3/4 XDM

40A female crimp contacts

1,5 mm ²	AWG 16
2,5 mm ²	AWG 14
4 mm ²	AWG 12
6 mm ²	AWG 10

RXF2D 1.5
RXF2D 2.5
RXF2D 4.0
RXF2D 6.0

40A male crimp contacts

1,5 mm ²	AWG 16
2,5 mm ²	AWG 14
4 mm ²	AWG 12
6 mm ²	AWG 10

RXM2D 1.5
RXM2D 2.5
RXM2D 4.0
RXM2D 6.0

10A female crimp contacts

0,14-0,37 mm ²	AWG 26-22	identification No. 1
0,5 mm ²	AWG 20	identification No. 2
0,75 mm ²	AWG 18	identification No. ②
1 mm ²	AWG 18	identification No. 3
1,5 mm ²	AWG 16	identification No. 4
2,5 mm ²	AWG 14	identification No. 5

RDF2D 0.3
RDF2D 0.5
RDF2D 0.7
RDF2D 1.0
RDF2D 1.5
RDF2D 2.5

10A male crimp contacts

0,14-0,37 mm ²	AWG 26-22	identification No. 1
0,5 mm ²	AWG 20	identification No. 2
0,75 mm ²	AWG 18	identification No. ②
1 mm ²	AWG 18	identification No. 3
1,5 mm ²	AWG 16	identification No. 4
2,5 mm ²	AWG 14	identification No. 5

RDM2D 0.3
RDM2D 0.5
RDM2D 0.7
RDM2D 1.0
RDM2D 1.5
RDM2D 2.5

gold plated

- characteristics according to EN 61984:

- 3 poles 40A 830V 8kV 3
- 4 poles 10A 830V 8kV 3
- cULus (UL for USA and Canada), CE, DNV-GL
- Bureau Veritas EAC certified
- rated voltage according to UL/CSA: 600V
- insulation resistance: ≥ 10 GΩ
- ambient temperature limit: -40 °C ... +125 °C
- made of self-extinguishing thermoplastic resin UL 94V-0
- mechanical life: ≥ 10.000 cycles
- contact resistance: ≤ 0,3 mΩ (3 poles), ≤ 3 mΩ (4 poles)
- for max. current load see the connector inserts derating diagram below; for more information see page 28

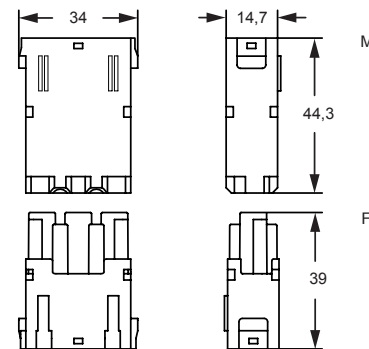

contacts side (front view)

side with reference arrow ▲

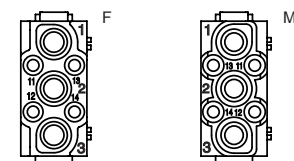

- 1 frame slot

- it is recommended to crimp the contacts with crimping tools homologated by ILME (please see the crimping tool section 40A contacts, RXF2D, RXM2D series and 10A contacts RDF2D, RDM2D series) on pages 708 - 741

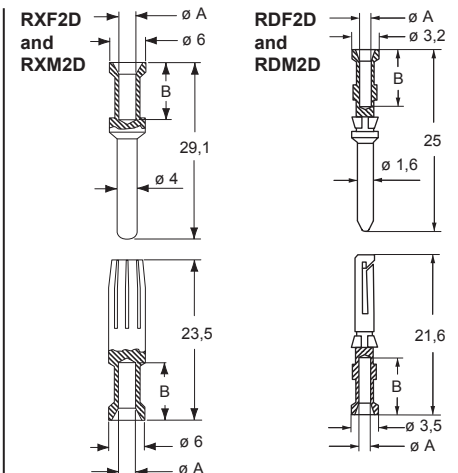

RXF2D and RXM2D contacts

conductor section (mm ²)	conductor slot ø A (mm)	conductors stripping length B (mm)
1,5	1,8	9
2,5	2,2	9
4	2,85	9,6
6	3,5	9,6

RDF2D and RDM2D contacts

0,14-0,37	0,9	8
0,5	1,1	8
0,75	1,3	8
1,0	1,45	8
1,5	1,8	8
2,5	2,2	6

CX 3/4 poles connector inserts
Maximum current load derating diagram

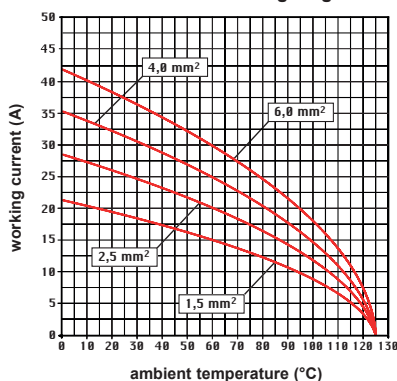



The modular inserts must be installed in suitable frames, which are then mounted in traditional enclosures* or in COB panel supports.

frames for modular units*

page: 333

* enclosures: bulkhead mounting housings, high construction housings or high construction hoods

modular units, crimp connections with red lock-in tab (included)

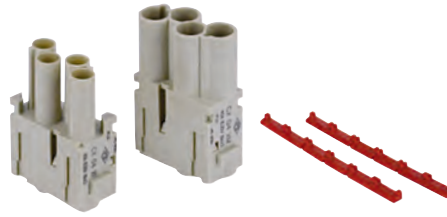

Q 10.000 MATINGS WITH HNM FRAMES AND HNM ENCLOSURES

Q 5.000 MATINGS WITH HNM FRAMES AND STANDARD ENCLOSURES, SINGLE LEVER

40A crimp contacts gold plated



description	part No.	part No.
-------------	----------	----------

without contacts (to be ordered separately)
(module red lock-in tab included)
female inserts for female contacts
male inserts for male contacts

CX 04 XF
CX 04 XM

40A female crimp contacts
1,5 mm² AWG 16
2,5 mm² AWG 14
4 mm² AWG 12
6 mm² AWG 10

RXF2D 1.5
RXF2D 2.5
RXF2D 4.0
RXF2D 6.0

gold plated

40A male crimp contacts
1,5 mm² AWG 16
2,5 mm² AWG 14
4 mm² AWG 12
6 mm² AWG 10

RXM2D 1.5
RXM2D 2.5
RXM2D 4.0
RXM2D 6.0

- characteristics according to EN 61984:

40A 830V 8kV 3
40A 1000V 8kV 2

- cULus (UL for USA and Canada),

certified

- rated voltage according to UL/CSA: 600V

- insulation resistance: $\geq 10 \text{ G}\Omega$

- ambient temperature limit: -40 °C ... +125 °C

- made of self-extinguishing thermoplastic resin UL 94V-0

- mechanical life: ≥ 10.000 cycles

- contact resistance: $\leq 0,3 \text{ m}\Omega$

- for spare lock-in tab **CX CFMX** see SPARE SPARTS catalogue

- it is recommended to crimp the contacts with crimping tools homologated by ILME (please see the crimping tool section 40A contacts, RXF2D and RXM2D series) on pages 708 - 741

- for max. current load see the connector inserts derating diagram below; for more information see page 28

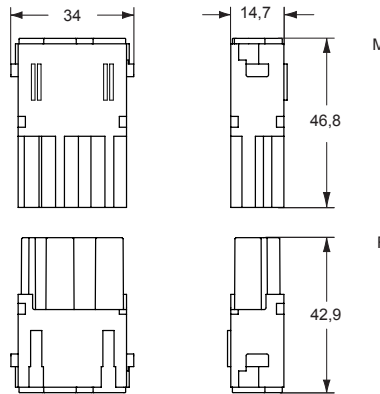

contacts side (front view)
side with reference arrow ▲

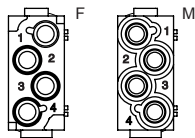

- 1 frame slot

Female inserts are supplied with two red lock tab that must be used instead of those supplied with the frames.

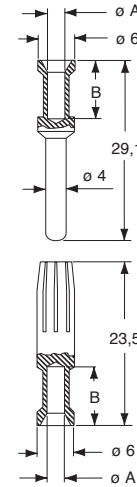
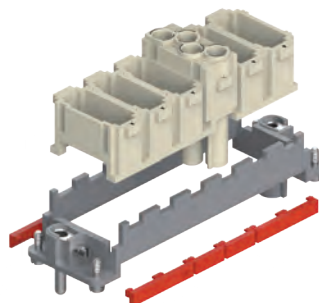

RXF2D and RXM2D contacts

conductor section (mm ²)	conductor slot $\varnothing A$ (mm)	conductor stripping length B (mm)
1,5	1,8	9
2,5	2,2	9
4	2,85	9,6
6	3,5	9,6

- male and female contacts finger proof
- their key characteristic lies in the fact that they guarantee maximum safety even in case of accidental contact with fingers (IP2X or IPXXB). Safety is guaranteed as standard on female contacts, but also on male contacts. This feature is important as it ensures full compliance with the recent safety standard EN 60204-1, concerning electric equipment fitted on machines and in particular with the requirements of Article 6.2.4 concerning protection against residual voltage. In the case of plugs or similar devices, the withdrawal of which results in the exposure of conductors (for example pins), the discharge time shall not exceed 1 s, otherwise such conductors shall be protected against direct contact to at least an IP2X or IPXXB.

CX 04 poles connector inserts
Maximum current load derating diagram

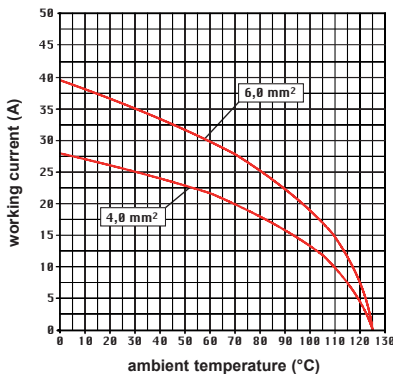

The modular inserts must be installed in suitable frames, which are then mounted in traditional enclosures or in COB panel supports.

frames for modular units

page: 333

- we recommend the use of CRF / CRM code pins

modular units, crimp connections



✍ RATING 830V

Q 10.000 MATINGS WITH HNM FRAMES AND HNM ENCLOSURES

Q 5.000 MATINGS WITH HNM FRAMES AND STANDARD ENCLOSURES, SINGLE LEVER

16A crimp contacts gold plated



description

part No.

part No.

without contacts (to be ordered separately)
female inserts for female contacts
male inserts for male contacts

CX 06P CF
CX 06P CM

16A female contacts

0,14-0,37 mm ²	AWG 26-22	one groove
0,5 mm ²	AWG 20	with no grooves
0,75 mm ²	AWG 18	one groove (back side)
1 mm ²	AWG 18	one groove
1,5 mm ²	AWG 16	two grooves
2,5 mm ²	AWG 14	three grooves
3 mm ²	AWG 12	one wide groove
4 mm ²	AWG 12	with no grooves

RCF2D 0.3
RCF2D 0.5
RCF2D 0.7
RCF2D 1.0
RCF2D 1.5
RCF2D 2.5
RCF2D 3.0
RCF2D 4.0

gold plated

16A male contacts

0,14-0,37 mm ²	AWG 26-22	one groove
0,5 mm ²	AWG 20	with no grooves
0,75 mm ²	AWG 18	one groove (back side)
1 mm ²	AWG 18	one groove
1,5 mm ²	AWG 16	two grooves
2,5 mm ²	AWG 14	three grooves
3 mm ²	AWG 12	one wide groove
4 mm ²	AWG 12	with no grooves

RCM2D 0.3
RCM2D 0.5
RCM2D 0.7
RCM2D 1.0
RCM2D 1.5
RCM2D 2.5
RCM2D 3.0
RCM2D 4.0

- characteristics according to EN 61984:

16A 830V 8kV 3

- **BUREAU VERITAS** certified
- rated voltage according to UL/CSA: 600V
- insulation resistance: ≥ 10 G Ω
- ambient temperature limit: -40 °C ... +125 °C
- made of self-extinguishing thermoplastic resin UL 94V-0
- mechanical life: ≥ 10.000 cycles
- contact resistance: ≤ 1 m Ω
- **it is recommended to crimp the contacts with crimping tools homologated by ILME** (please see the crimping tool section 16A contacts, RCF2D and RCM2D series) on pages 708 - 741
- for max. current load see the connector inserts derating diagram below; for more information see page 28

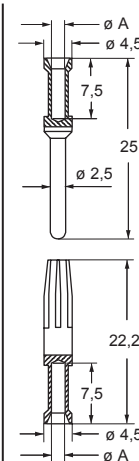
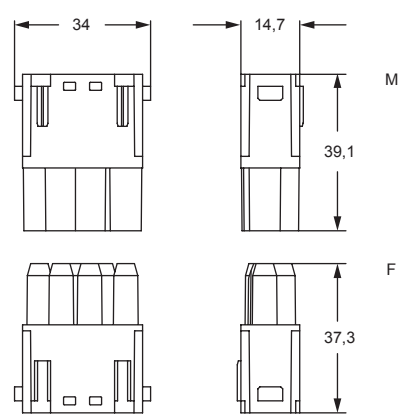

RCF2D and RCM2D contacts

conductor section (mm ²)	conductor slot $\varnothing A$ (mm)	conductors stripping length (mm)
0,14-0,37	0,9	7,5
0,5	1,1	7,5
0,75	1,3	7,5
1,0	1,45	7,5
1,5	1,8	7,5
2,5	2,2	7,5
3	2,55	7,5
4	2,85	7,5

CX..P 06 poles connector inserts
Maximum current load derating diagram

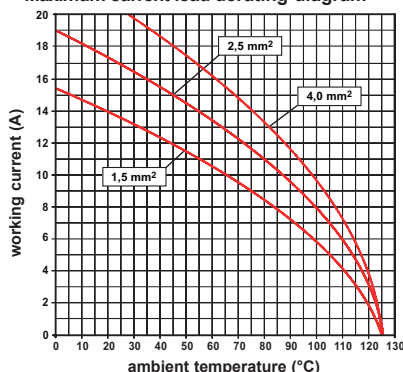

contacts side (front view)

side with reference arrow ▲

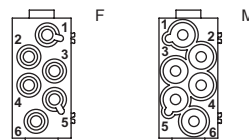

- 1 frame slot



The modular inserts must be installed in suitable frames, which are then mounted in traditional enclosures or in COB panel supports.

frames for modular units

page: 333

modular units, crimp connections

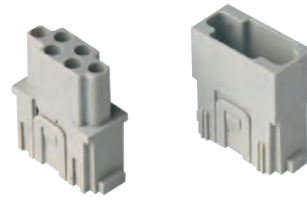

Q 10.000 MATINGS WITH HNM FRAMES AND HNM ENCLOSURES

Q 5.000 MATINGS WITH HNM FRAMES AND STANDARD ENCLOSURES, SINGLE LEVER

16A crimp contacts gold plated



description	part No.	part No.
-------------	----------	----------

without contacts (to be ordered separately)
female inserts for female contacts
male inserts for male contacts

CX 06 CF
CX 06 CM

16A female contacts

Area (mm ²)	AWG	Configuration
0,14-0,37	26-22	one groove
0,5	20	with no grooves
0,75	18	one groove (back side)
1	18	one groove
1,5	16	two grooves
2,5	14	three grooves
3	12	one wide groove
4	12	with no grooves

RCF2D 0.3
RCF2D 0.5
RCF2D 0.7
RCF2D 1.0
RCF2D 1.5
RCF2D 2.5
RCF2D 3.0
RCF2D 4.0

gold plated

16A male contacts

Area (mm ²)	AWG	Configuration
0,14-0,37	26-22	one groove
0,5	20	with no grooves
0,75	18	one groove (back side)
1	18	one groove
1,5	16	two grooves
2,5	14	three grooves
3	12	one wide groove
4	12	with no grooves

RCM2D 0.3
RCM2D 0.5
RCM2D 0.7
RCM2D 1.0
RCM2D 1.5
RCM2D 2.5
RCM2D 3.0
RCM2D 4.0

- characteristics according to EN 61984:

16A 500V 6kV 3
16A 400/690V 6kV 2

- certified

- rated voltage according to UL/CSA: 600V

- insulation resistance: $\geq 10 \text{ G}\Omega$

- ambient temperature limit: $-40 \text{ }^\circ\text{C} \dots +125 \text{ }^\circ\text{C}$

- made of self-extinguishing thermoplastic resin UL 94V-0

- mechanical life: ≥ 10.000 cycles

- contact resistance: $\leq 1 \text{ m}\Omega$

- it is recommended to crimp the contacts with crimping tools homologated by ILME (please see the crimping tool section 16A contacts, RCF2D and RCM2D series) on pages 708 - 741

- for max. current load see the connector inserts derating diagram below; for more information see page 28

CX 06 poles connector inserts
Maximum current load derating diagram

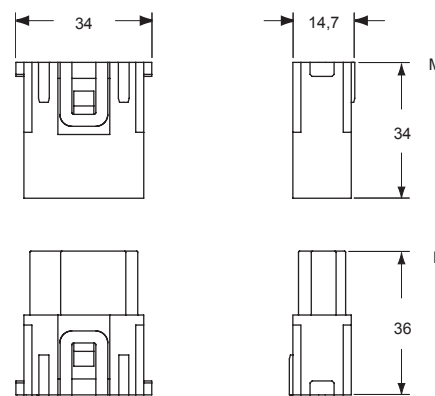
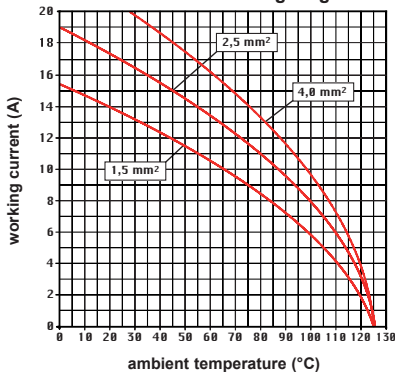

contacts side (front view)

side with reference arrow ▲

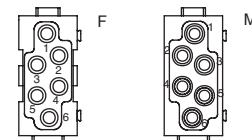

- 1 frame slot

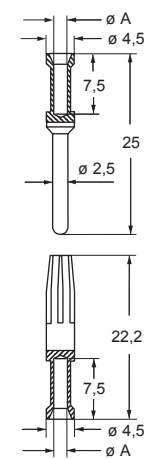

RCF2D and RCM2D contacts

conductor section mm ²	conductor slot $\varnothing A$ (mm)	conductors stripping length (mm)
0,14-0,37	0,9	7,5
0,5	1,1	7,5
0,75	1,3	7,5
1,0	1,45	7,5
1,5	1,8	7,5
2,5	2,2	7,5
3	2,55	7,5
4	2,85	7,5

The modular inserts must be installed in suitable frames, which are then mounted in traditional enclosures or in COB panel supports.

frames for modular units

page: 333

modular units, crimp connections



Q 10.000 MATINGS WITH HNM FRAMES AND HNM ENCLOSURES

Q 5.000 MATINGS WITH HNM FRAMES AND STANDARD ENCLOSURES, SINGLE LEVER

16A crimp contacts gold plated



description

part No.

part No

without contacts (to be ordered separately)
female inserts for female contacts
male inserts for male contacts

CX 08 CF
CX 08 CM

16A female contacts

0,14-0,37 mm ²	AWG 26-22	one groove
0,5 mm ²	AWG 20	with no grooves
0,75 mm ²	AWG 18	one groove (back side)
1 mm ²	AWG 18	one groove
1,5 mm ²	AWG 16	two grooves
2,5 mm ²	AWG 14	three grooves
3 mm ²	AWG 12	one wide groove
4 mm ²	AWG 12	with no grooves

RCF2D 0.3
RCF2D 0.5
RCF2D 0.7
RCF2D 1.0
RCF2D 1.5
RCF2D 2.5
RCF2D 3.0
RCF2D 4.0

gold plated

16A male contacts

0,14-0,37 mm ²	AWG 26-22	one groove
0,5 mm ²	AWG 20	with no grooves
0,75 mm ²	AWG 18	one groove (back side)
1 mm ²	AWG 18	one groove
1,5 mm ²	AWG 16	two grooves
2,5 mm ²	AWG 14	three grooves
3 mm ²	AWG 12	one wide groove
4 mm ²	AWG 12	with no grooves

RCM2D 0.3
RCM2D 0.5
RCM2D 0.7
RCM2D 1.0
RCM2D 1.5
RCM2D 2.5
RCM2D 3.0
RCM2D 4.0

- characteristics according to EN 61984:

16A 500V 6kV 3
16A 400/690V 6kV 2

- certified

- rated voltage according to UL/CSA: 600V

- insulation resistance: ≥ 10 GΩ

- ambient temperature limit: -40 °C ... +125 °C

- made of self-extinguishing thermoplastic resin UL 94V-0

- mechanical life: ≥ 10.000 cycles

- contact resistance: ≤ 1 mΩ

- **it is recommended to crimp the contacts with crimping tools homologated by ILME** (please see the crimping tool section 16A contacts, RCF2D and RCM2D series) on pages 708 - 741

- for max. current load see the connector inserts derating diagram below; for more information see page 28

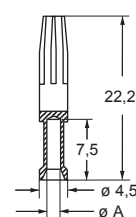
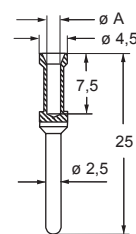
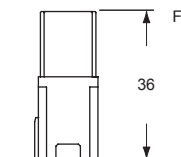
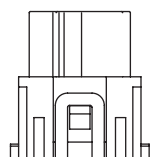
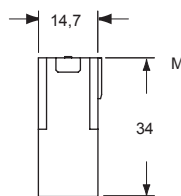
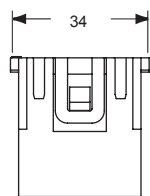

RCF2D and RCM2D contacts

conductor section mm ²	conductor slot ø A (mm)	conductors stripping length (mm)
0,14-0,37	0,9	7,5
0,5	1,1	7,5
0,75	1,3	7,5
1,0	1,45	7,5
1,5	1,8	7,5
2,5	2,2	7,5
3	2,55	7,5
4	2,85	7,5

CX 08 C, 8 poles connector inserts
Maximum current load derating diagram

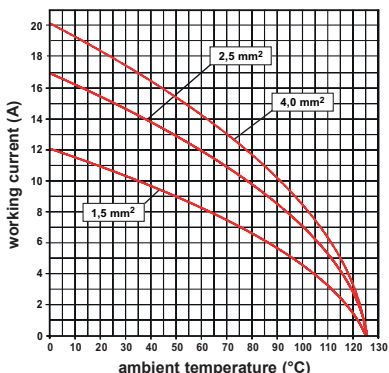

contacts side (front view)

side with reference arrow ▲

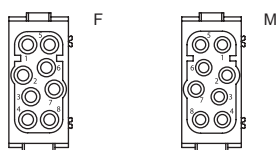

- 1 frame slot

The modular inserts must be installed in suitable frames, which are then mounted in traditional enclosures or in COB panel supports.

frames for modular units

page: 333

modular units, crimp connections



Q 10.000 MATINGS WITH HNM FRAMES AND HNM ENCLOSURES

Q 5.000 MATINGS WITH HNM FRAMES AND STANDARD ENCLOSURES, SINGLE LEVER

16A crimp contacts gold plated



description	part No.	part No.
-------------	----------	----------

without contacts (to be ordered separately)
 female inserts for female contacts ¹⁾
 male inserts for male contacts ¹⁾

CX 20 CF
CX 20 CM

16A female contacts

Area (mm²)	AWG	Configuration
0,14-0,37	26-22	one groove
0,5	20	with no grooves
0,75	18	one groove (back side)
1	18	one groove
1,5	16	two grooves
2,5	14	three grooves
3	12	one wide groove
4	12	with no grooves

- RCF2D 0.3
- RCF2D 0.5
- RCF2D 0.7
- RCF2D 1.0
- RCF2D 1.5
- RCF2D 2.5
- RCF2D 3.0
- RCF2D 4.0

gold plated

16A male contacts

Area (mm²)	AWG	Configuration
0,14-0,37	26-22	one groove
0,5	20	with no grooves
0,75	18	one groove (back side)
1	18	one groove
1,5	16	two grooves
2,5	14	three grooves
3	12	one wide groove
4	12	with no grooves

- RCM2D 0.3
- RCM2D 0.5
- RCM2D 0.7
- RCM2D 1.0
- RCM2D 1.5
- RCM2D 2.5
- RCM2D 3.0
- RCM2D 4.0

¹⁾ on request, version with 3 fastened CX 20 CF/CM inserts with poles numbered from 1 – 60
 references: **CX 60 CF**, **CX 60 CM**

- characteristics according to EN 61984:
16A 500V 6kV 3
16A 830V 8kV 2
- certified
- rated voltage according to UL/CSA: 600V
- insulation resistance: ≥ 10 GΩ
- ambient temperature limit: -40 °C ... +125 °C
- made of self-extinguishing thermoplastic resin UL 94V-0
- mechanical life: ≥ 10.000 cycles
- contact resistance: ≤ 1 mΩ
- **it is recommended to crimp the contacts with crimping tools homologated by ILME** (please see the crimping tool section 16A contacts, RCF2D and RCM2D series) on pages 708 - 741
- for max. current load see the connector inserts derating diagram below; for more information see page 28

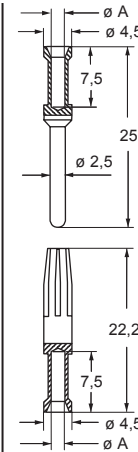
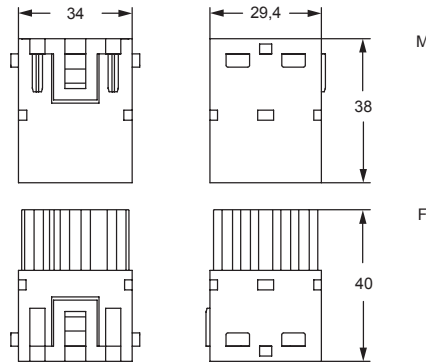

CX20 poles connector inserts
Maximum current load derating diagram

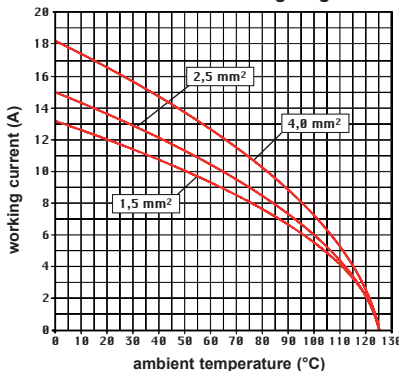

contacts side (front view)

side with reference arrow ▲

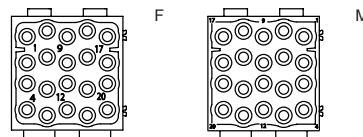

- 2 frame slots

RCF2D and RCM2D contacts

conductor section mm²	conductor slot ø A (mm)	conductors stripping length (mm)
0,14-0,37	0,9	7,5
0,5	1,1	7,5
0,75	1,3	7,5
1,0	1,45	7,5
1,5	1,8	7,5
2,5	2,2	7,5
3	2,55	7,5
4	2,85	7,5

The modular inserts must be installed in suitable frames, which are then mounted in traditional enclosures* or in COB panel supports.

frames for modular units*

page: 333

* enclosures: bulkhead mounting housings, high construction housings or high construction hoods

modular units, crimp connections

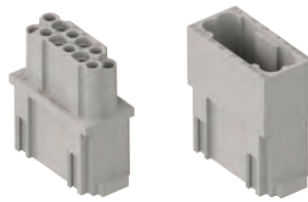

RATING 250V

Q 10.000 MATINGS WITH HNM FRAMES AND HNM ENCLOSURES

Q 5.000 MATINGS WITH HNM FRAMES AND STANDARD ENCLOSURES, SINGLE LEVER

10A crimp contacts gold plated



description

part No.

part No

without contacts (to be ordered separately)
female inserts for female contacts
male inserts for male contacts

CX 12 DF
CX 12 DM

10A female contacts

0,14-0,37 mm ²	AWG 26-22	identification No. 1
0,5 mm ²	AWG 20	identification No. 2
0,75 mm ²	AWG 18	identification No. ②
1 mm ²	AWG 18	identification No. 3
1,5 mm ²	AWG 16	identification No. 4
2,5 mm ²	AWG 14	identification No. 5

RDF2D 0.3	gold plated
RDF2D 0.5	
RDF2D 0.7	
RDF2D 1.0	
RDF2D 1.5	
RDF2D 2.5	

10A male contacts

0,14-0,37 mm ²	AWG 26-22	identification No. 1
0,5 mm ²	AWG 20	identification No. 2
0,75 mm ²	AWG 18	identification No. ②
1 mm ²	AWG 18	identification No. 3
1,5 mm ²	AWG 16	identification No. 4
2,5 mm ²	AWG 14	identification No. 5

RDM2D 0.3	gold plated
RDM2D 0.5	
RDM2D 0.7	
RDM2D 1.0	
RDM2D 1.5	
RDM2D 2.5	

- characteristics according to EN 61984:

10A 250V 4kV 3

- certified
- rated voltage according to UL/CSA: 600V
- insulation resistance: ≥ 10 GΩ
- ambient temperature limit: -40 °C ... +125 °C
- made of self-extinguishing thermoplastic resin UL 94V-0
- mechanical life: ≥ 10.000 cycles
- contact resistance: ≤ 3 mΩ
- PCBs interface, refer to article CIF 2.4 on page 670
- **it is recommended to crimp the contacts with crimping tools homologated by ILME** (please see the crimping tool section 10A contacts, RDF2D and RDM2D series) on pages 708 - 741
- for max. current load see the connector inserts derating diagram below; for more information see page 28

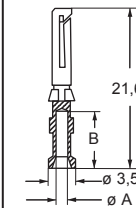
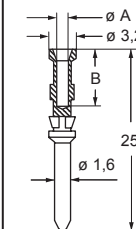
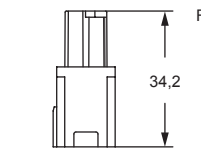
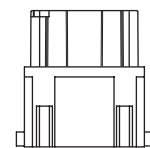
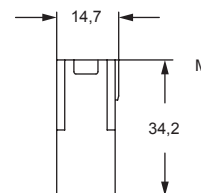
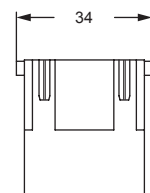

contacts side (front view)

side with reference arrow ▲

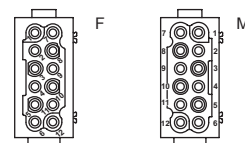

- 1 frame slot

RDF2D and RDM2D contacts

conductor section mm ²	conductor slot Ø A (mm)	conductors stripping length B (mm)
0,14-0,37	0,9	8
0,5	1,1	8
0,75	1,3	8
1,0	1,45	8
1,5	1,8	8
2,5	2,2	6

CX 12 poles connector inserts
Maximum current load derating diagram

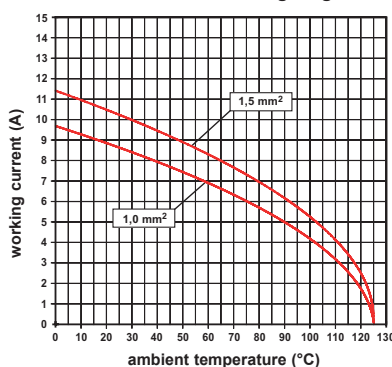



The modular inserts must be installed in suitable frames, which are then mounted in traditional enclosures or in COB panel supports.

frames for modular units

page: 333

modular units, crimp connections

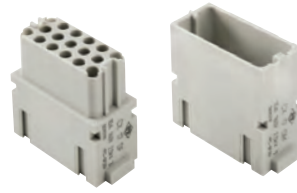

Q 10.000 MATINGS WITH HNM FRAMES AND HNM ENCLOSURES

Q 5.000 MATINGS WITH HNM FRAMES AND STANDARD ENCLOSURES, SINGLE LEVER

10A crimp contacts, gold plated



description	part No.	part No.
-------------	----------	----------

without contacts (to be ordered separately)
female inserts for female contacts
male inserts for male contacts

CX 17 DF
CX 17 DM

10A female contacts

area	AWG	identification No.
0,14-0,37 mm ²	AWG 26-22	identification No. 1
0,5 mm ²	AWG 20	identification No. 2
0,75 mm ²	AWG 18	identification No. ②
1 mm ²	AWG 18	identification No. 3
1,5 mm ²	AWG 16	identification No. 4
2,5 mm ²	AWG 14	identification No. 5

RDF2D 0.3
RDF2D 0.5
RDF2D 0.7
RDF2D 1.0
RDF2D 1.5
RDF2D 2.5

gold plated

10A male contacts

area	AWG	identification No.
0,14-0,37 mm ²	AWG 26-22	identification No. 1
0,5 mm ²	AWG 20	identification No. 2
0,75 mm ²	AWG 18	identification No. ②
1 mm ²	AWG 18	identification No. 3
1,5 mm ²	AWG 16	identification No. 4
2,5 mm ²	AWG 14	identification No. 5

RDM2D 0.3
RDM2D 0.5
RDM2D 0.7
RDM2D 1.0
RDM2D 1.5
RDM2D 2.5

- characteristics according to EN 61984:

10A 160V 2,5kV 3
10A 250V 4kV 2

- cULus (UL for USA and Canada), SP, ccc, DNV-GL

- BUREAU VERITAS EAC certified

- rated voltage according to UL/CSA: 250V

- insulation resistance: ≥ 10 GΩ

- ambient temperature limit: -40 °C ... +125 °C

- made of self-extinguishing thermoplastic resin UL 94V-0

- mechanical life: ≥ 10.000 cycles

- contact resistance: ≤ 3 mΩ

- it is recommended to crimp the contacts with crimping tools homologated by ILME (please see the crimping tool section 10A contacts, RDF2D and RDM2D series) on pages 708 - 741

- for max. current load see the connector inserts derating diagram below; for more information see page 28

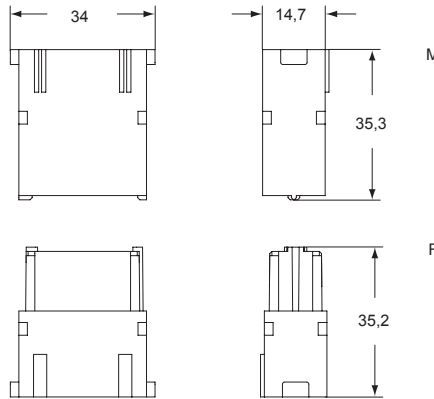

contacts side (front view)

side with reference arrow ▲

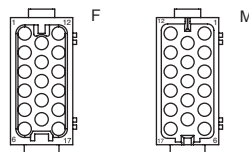

- 1 frame slot

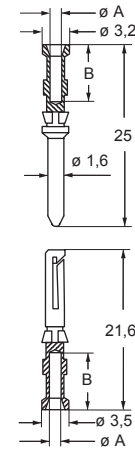

RDF2D and RDM2D contacts

conductor section	conductor slot	conductors stripping length
mm ²	ø A (mm)	B (mm)
0,14-0,37	0,9	8
0,5	1,1	8
0,75	1,3	8
1,0	1,45	8
1,5	1,8	8
2,5	2,2	6

CX 17 poles connector inserts
Maximum current load derating diagram

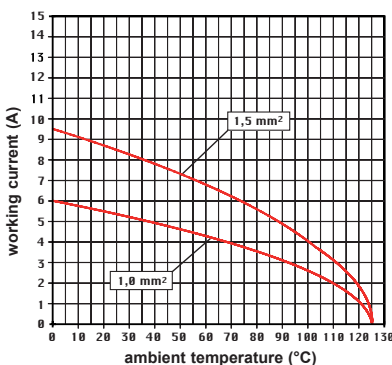

The modular inserts must be installed in suitable frames, which are then mounted in traditional enclosures* or in COB panel supports.

frames for modular units*

page: 333

* enclosures: bulkhead mounting housings, high construction housings or high construction hoods

modular units, crimp connections

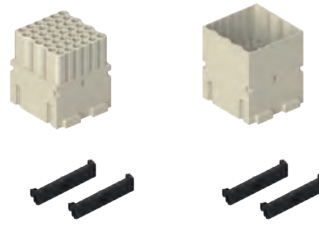

Q 10.000 MATINGS WITH HNM FRAMES AND HNM ENCLOSURES

Q 5.000 MATINGS WITH HNM FRAMES AND STANDARD ENCLOSURES, SINGLE LEVER

10A crimp contacts gold plated



description

part No.

part No.

without contacts (to be ordered separately), supplied with 2 dedicated black coloured 2-slot sized lock-in tab female inserts for female contacts male inserts for male contacts

**CX 42 DF
CX 42 DM**

10A female contacts

0,14-0,37 mm ²	AWG 26-22	identification No. 1
0,5 mm ²	AWG 20	identification No. 2
0,75 mm ²	AWG 18	identification No. ②
1 mm ²	AWG 18	identification No. 3
1,5 mm ²	AWG 16	identification No. 4
2,5 mm ²	AWG 14	identification No. 5

gold plated

RDF2D 0.3
RDF2D 0.5
RDF2D 0.7
RDF2D 1.0
RDF2D 1.5
RDF2D 2.5

10A male contacts

0,14-0,37 mm ²	AWG 26-22	identification No. 1
0,5 mm ²	AWG 20	identification No. 2
0,75 mm ²	AWG 18	identification No. ②
1 mm ²	AWG 18	identification No. 3
1,5 mm ²	AWG 16	identification No. 4
2,5 mm ²	AWG 14	identification No. 5

RDM2D 0.3
RDM2D 0.5
RDM2D 0.7
RDM2D 1.0
RDM2D 1.5
RDM2D 2.5

- characteristics according to EN 61984:
- 10A 150V 2,5kV 3**
- cULus (UL for USA and Canada) certified, CSA, CQC, DNV-GL, BV, EAC pending
- rated voltage according to UL/CSA: 250V
- insulation resistance: $\geq 10 \text{ G}\Omega$
- ambient temperature limit: -40 °C ... +125 °C
- made of self-extinguishing thermoplastic resin UL 94V-0
- mechanical life: ≥ 10.000 cycles
- contact resistance: $\leq 3 \text{ m}\Omega$
- supplied with dedicated black coloured 2-slot sized lock-in tab (2, one per each side).
- for spare lock-in tab **CX CFMD** see SPARE SPARTS catalogue
- **it is recommended to crimp the contacts with crimping tools homologated by ILME** (please see the crimping tool section 10A contacts, RDF2D and RDM2D series) on pages 708 - 741
- for max. current load see the connector inserts derating diagram below; for more information see page 28

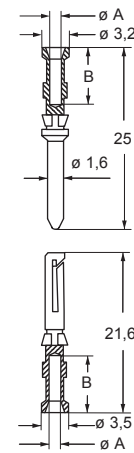
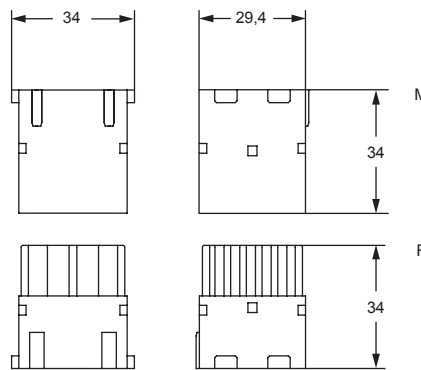

CX 42 D, 42 poles connector inserts
Maximum current load derating diagram

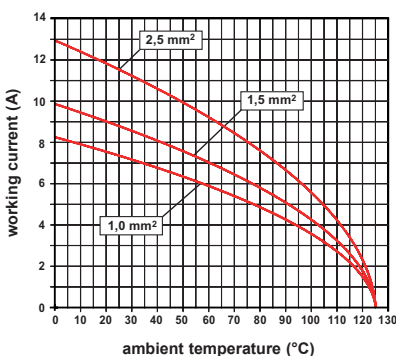

contacts side (front view)

rear view, side with reference arrow ▲

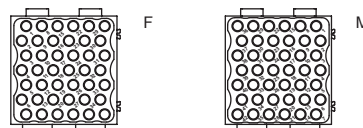

- 2 frame slots

RDF2D and RDM2D contacts

conductor cross-sectional area mm ²	conductor slot $\varnothing A$ (mm)	conductor stripping length B (mm)
0,14-0,37	0,9	8
0,5	1,1	8
0,75	1,3	8
1,0	1,45	8
1,5	1,8	8
2,5	2,2	6



enclosures size:		page:
"44.27"	HNM	592 - 593
	C-TYPE IP65 or IP66/IP69, single lever	387 - 392
	V-TYPE IP65 or IP66/IP69, single lever	444 - 447
	E-Xtreme® corrosion proof	530 - 531
		542, 550 - 551
"57.27"	HNM	594 - 595
	C-TYPE IP65 or IP66/IP69, single lever	393 - 401
	V-TYPE IP65 or IP66/IP69, single lever	448 - 453
	E-Xtreme® corrosion proof	532 - 533
		543, 552 - 553
"77.27"	HNM	596 - 597
	C-TYPE IP65 or IP66/IP69, single lever	402 - 411
	V-TYPE IP65 or IP66/IP69, single lever	454 - 458
	E-Xtreme® corrosion proof	534 - 535
		544, 554 - 555
"104.27"	HNM	598 - 599
	C-TYPE IP65 or IP66/IP69, single lever	412 - 423
	V-TYPE IP65 or IP66/IP69, single lever	459 - 463
	E-Xtreme® corrosion proof	536 - 537
		545, 556 - 557
"77.62"	C-TYPE IP65 or IP66/IP69, single lever	424 - 429
	E-Xtreme® corrosion proof	546
"104.62"	C-TYPE IP65 or IP66/IP69, single lever	430
	E-Xtreme® corrosion proof	547

C-TYPE and V-TYPE 2-lever versions cannot be used to reach 5.000 matings.

frames for modular units with lock-in tab (included)

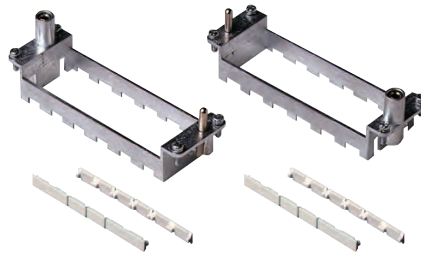

- Q 10.000 MATINGS WITH HNM FRAMES AND HNM ENCLOSURES
- Q 5.000 MATINGS WITH HNM FRAMES AND STANDARD ENCLOSURES, SINGLE LEVER

description	part No.	part No.
-------------	----------	----------

frames for modular units with lock-in tab included
 for 2 modular units - for housing size 44.27
 for 3 modular units - for housing size 57.27
 for 4 modular units - for housing size 77.27 and 77.62
 for 6 modular units - for housing size 104.27 and 104.62

type for hoods*	type for housings*
RX 02 TM	RX 02 TF
RX 03 TM	RX 03 TF
RX 04 TM	RX 04 TF
RX 06 TM	RX 06 TF

- die-cast zinc alloy frames
- protective earth (PE)
- possibility of mounting female and male modular units on the same frame
- frames supplied with lock-in tab to attach units
- polarisation on frames
- coding pins **CR..CX**
- for spare lock-in tab **CX CFM** see SPARE SPARTS catalogue

* Assignment of attribute "for hoods" or "for housings" is merely conventional: both types can be mounted either in a hood or in a housing. In a modular connector coupling there shall be always a frame type "M" and a frame type "F".

RX TM / TF

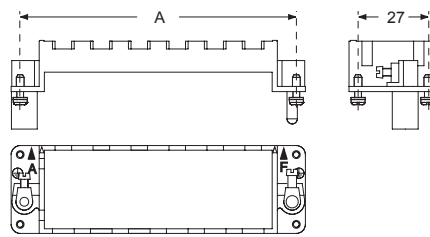

part No.	A (mm)	for housings size
RX 02 TM / TF	44	44.27
RX 03 TM / TF	57	57.27
RX 04 TM / TF	77,5	77.27 and 77.62
RX 06 TM / TF	104	104.27 and 104.62

Earth terminal

- large: for cables from 4-6 mm², AWG 12-10
- small: for cables from 1-2,5 mm², AWG 18-14

In order to accommodate larger PE conductor cross-sectional area, use CGT PE adapters, see page 319.

position of modules (contact side view)

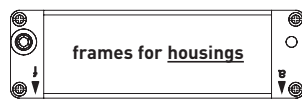
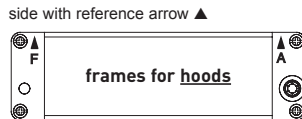

CX CFM (lock-in tab)

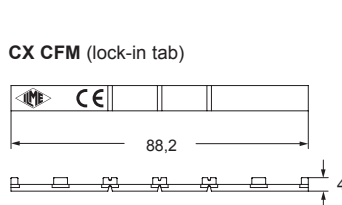

Polarisation of frames with relative identification letters and couplings

frame for hoods¹⁾ frames for housings¹⁾

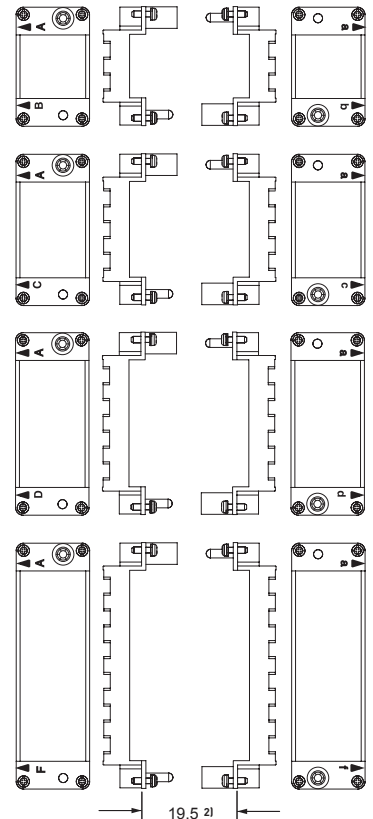

1) Warning:

- The module support frames are marked:
- FOR HOODS: **upper-case A-B, A-C, A-D and A-F**
- FOR HOUSINGS: **lower-case a-b, a-c, a-d and a-f**

Positioning the modules in the frames according to the respective letters is ensuring the specular assembly of modules, for which the hood will be coupled correctly to the housing.

2) Distance for:

- electric and fibre optic contacts: max 21 mm
- pneumatic contacts: max 20,5 mm

MIXO - HNM