

CZ - CZA and MZA IL-BRID standard version

inserts

CD	25 poles + ⊕
CDD	38 poles + ⊕
CDA	16 poles + ⊕
CSAH	16 poles + ⊕
CDC	16 poles + ⊕

page:

69
77
100
101
105

bulkhead mounting housings with single lever



surface mounting housings with single lever



description	part No.	part No.	entry Pg	part No.	entry M
with single lever	CZI 25 L				
with single lever and cover	CZI 25 LS				
with single lever, high construction		CZAP 25 L	16		
with single lever, high construction		CZAP 25 L2	16 x 2		
with single lever, high construction		CZAP 25 L21	21	MZAP 25 L25	25
with single lever, high construction		CZAP 25 L221	21 x 2	MZAP 25 L225	25 x 2
with single lever and cover, high construction		CZAP 25 LS	16		
with single lever and cover, high construction		CZAP 25 LS2	16 x 2		
with single lever and cover, high construction		CZAP 25 LS21	21	MZAP 25 LS25	25
with single lever and cover, high construction		CZAP 25LS221	21 x 2	MZAP 25LS225	25 x 2

☑ The enclosures ensure IP66/IP69 degree of protection (or IP65 for hinged cover versions) when mated and locked with the closing levers.

panel cut-out for bulkhead mounting housings

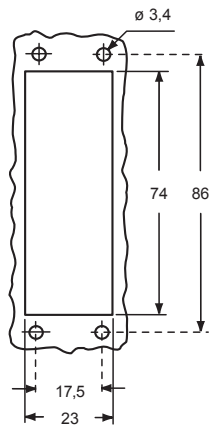

CZI L ▲

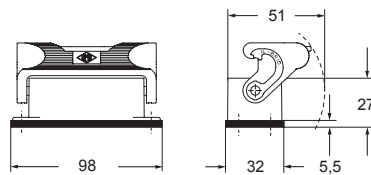

CZI LS ●

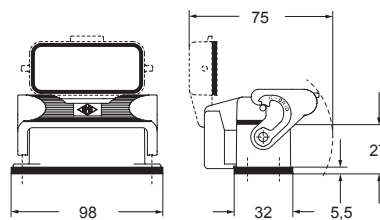

CZAP L and MZAP L ▲

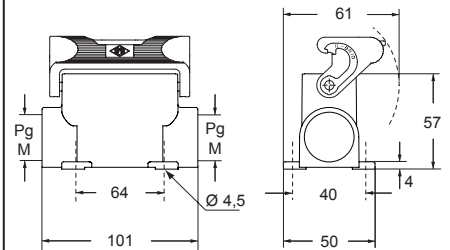

CZAP LS and MZAP LS ●

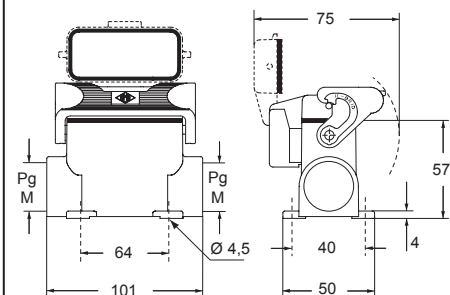

CALUS® Type 4/4X/12



● insulating cable gland or fittings
▲ without gasket



▲ cable gland with O-Ring gasket

CZ - CZA and MZA IL-BRID lever standard version SIMPLEX self-closing covers

inserts		page:
CD	25 poles + ⊕	69
CDD	38 poles + ⊕	77
CDA	16 poles + ⊕	100
CSAH	16 poles + ⊕	101
CDC	16 poles + ⊕	105

bulkhead mounting housings with single lever



surface mounting housings with single lever



description	part No.	part No.	entry Pg	part No.	entry M
with single lever and cover	CZI 25 LSP				
with lever and cover, high construction		CZAP 25LSP16	16	MZAP 25LSP20	20
with lever and cover, high construction		CZAP 25LSP21	21	MZAP 25LSP25	25

☑ The enclosures ensure IP65 degree of protection when mated and locked with the closing lever, or IP44 protection when not mated and locked with lever, thanks to the SIMPLEX self-closing cover.

panel cut-out for bulkhead mounting housings

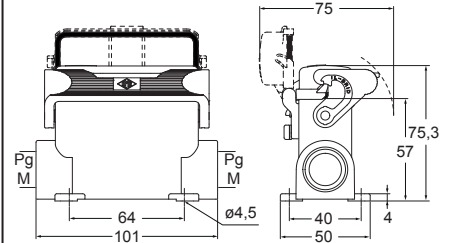
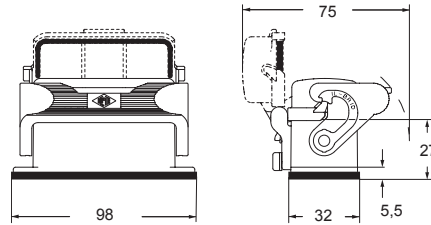
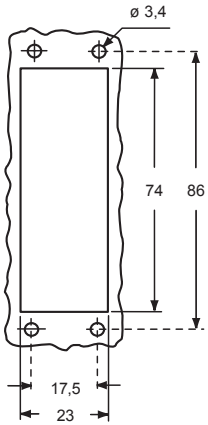

CAIUS Type 4/4X/12



CAIUS Type 4/4X/12 pending



CZ - CZA - CZF and MZ - MZA - MZF IL-BRID standard version

inserts

CD	25 poles + ⊕
CDD	38 poles + ⊕
CDA	16 poles + ⊕
CSAH	16 poles + ⊕
CDC	16 poles + ⊕

page:

69
77
100
101
105

hoods with 2 pegs

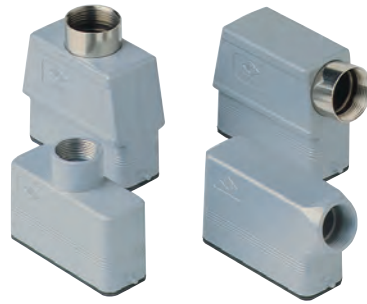

hoods with 2 pegs, double top entry



description	part No.	entry Pg	part No.	entry M	part No.	entry Pg	part No.	entry M
side entry	CZO 25 L	16	MZO 25 L20	20				
side entry			MZO 25 L25	25				
side entry, high construction	CZAO 25 L16	16	MZAO 25 L20	20				
side entry, high construction	CZAO 25 L21	21	MZAO 25 L25	25				
top entry	CZV 25 L	16						
top entry 2)			MZV 25 L20	20				
top entry, high construction	CZAV 25 L16	16	MZAV 25 L20	20				
top entry, high construction	CZAV 25 L21	21	MZAV 25 L25	25				
side entry, high construction, without adapter 1)	CZFO 25 L16	16	MZFO 25 L20	20				
side entry, high construction, without adapter 1)	CZFO 25 L21	21	MZFO 25 L25	25				
top entry, high construction, without adapter 1)	CZFV 25 L16	16	MZFV 25 L20	20				
top entry, high construction, without adapter 1)	CZFV 25 L21	21	MZFV 25 L25	25				
with pegs for 1 lever, high construction					CZAV 25 L216	16 x 2	MZAV 25 L220	20 x 2
with pegs for 1 lever, high construction, without adapter 1)					CZFV 25 L216	16 x 2	MZFV 25 L220	20 x 2

1) enclosure without adapter, threaded on the body, to be used only with a complete cable gland.

2) can only be used with a complete cable gland (to be purchased separately).

CZO L and MZO L ▲

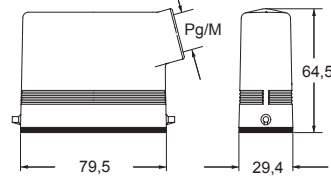

CZAO L - MZAO L and CZAV L - MZAV L ▲

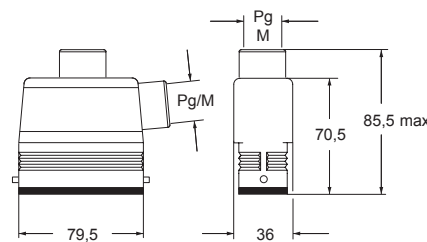

CZV L and MZV L ▲

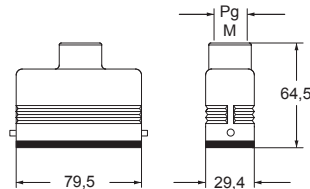

CZFO L - MZFO L and CZFV L - MZFV L ●

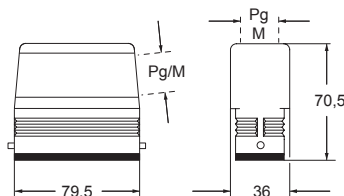

CZAV/CZFV L2 and (MZAV)/MZFV L2 ●

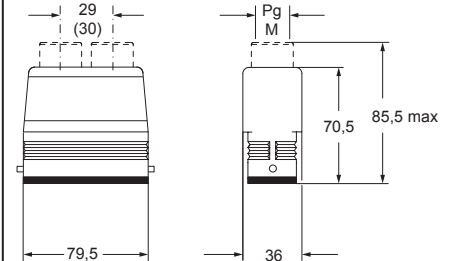

CALUS Type 4/4X/12

▲ ● insulating cable gland or fittings without gasket

▲ cable gland with O-Ring gasket

● cable gland with O-Ring gasket
 IP67 if hoods with fused pegs and without adapters, coupled with IP67 housings

CZ and MZ IL-BRID standard version

inserts		page:
CD	25 poles + ⊕	69
CDD	38 poles + ⊕	77
CDA	16 poles + ⊕	100
CSAH	16 poles + ⊕	101
CDC	16 poles + ⊕	105

hoods with single lever



covers



description	part No.	entry Pg	part No.	entry M	part No. (with eyelet)	part No. (with loop)
with single lever, top entry	CZV 25 LG	16	MZV 25 LG20	20		
with pegs and gasket (for 1 lever enclosures)					CZC 25 L	CZC 25 SL
with lever (for enclosures with pegs)						CZC 25 LG

CZV LG and MZV LG ▲

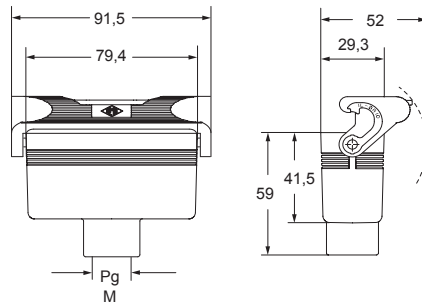

CZC L (SL) ●

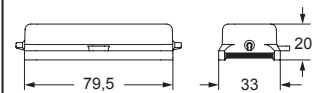

CZC LG ▲

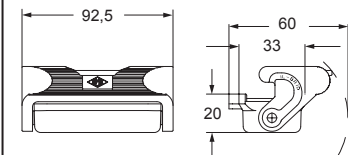

For fixing on housings

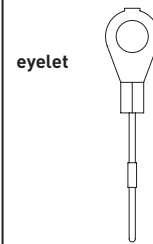

For fixing on hoods

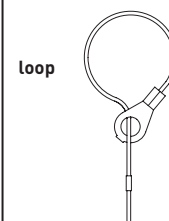

CAIUS Type 4/4X/12



▲ insulating cable gland or fittings without gasket



▲ cable gland with O-Ring gasket



● IP67 if coupled with CZ7 - MZ7 housings (see page 385)